



# REFERENCE GUIDE

## AMU 2.4.0

AML  
MANAGEMENT  
UNIT

---

E-2.4.0-02E-1.0

---

Order No. DOC E00 005

---



## Table of Content

---

### 1 Before You Work with this Manual

---

1.1	Explanation of Symbols and Notes .....	1 -1
1.2	Hazard Alert Messages .....	1 -2
1.3	Assistance .....	1 -3
1.4	About this Manual .....	1 -4
1.5	Copyright .....	1 -5
1.6	Product Observation .....	1 -6

### 2 About AMU

---

2.1	Introduction .....	2 -1
2.2	Hardware .....	2 -11
2.3	Software .....	2 -14
2.4	AML Coordinates (ABBA/1 Format) .....	2 -17

### 3 Operating Console

---

3.1	Operation .....	3 -1
3.2	Overview of Menus .....	3 -4
3.3	Menu File .....	3 -5
3.4	Menu Edit .....	3 -8
3.5	Menu View .....	3 -9
3.6	Menu Options .....	3 -18
3.7	Menu Commands .....	3 -20
3.8	Menu Service .....	3 -43
3.9	Menu Window .....	3 -55
3.10	Menu Help .....	3 -56
3.11	Configuration .....	3 -57
3.12	Trace Levels .....	3 -97

## 4 Utilities

---

4.1 Rho File Manager .....	4 -1
4.2 "JUSTUTIL.EXE" .....	4 -16
4.3 LOG2ASC .....	4 -21
4.4 AMU Archive Catalog (Database) .....	4 -22
4.5 Adding a New User .....	4 -33
4.6 OS/2 Commands .....	4 -35
4.7 Disaster Recovery Support .....	4 -37

## 5 Procedures

---

5.1 Switching the AMU Computer On .....	5 -1
5.2 Starting the AMU Operating Console .....	5 -2
5.3 Terminating the AMU Operating Console .....	5 -3
5.4 Remote Power ON/OFF .....	5 -4
5.5 Switching Over between the Dual-AMU Computers .....	5 -5

## 6 Error Messages and Trouble Shooting

---

6.1 General Information .....	6 -1
6.2 Host Computer Error Codes .....	6 -2
6.3 AMU Error Messages and System Information .....	6 -4

## 7 Appendix

---

7.1 Terms Used .....	7 -1
7.2 Component Types .....	7 -4
7.3 List of Documents AML/2 .....	7 -8
7.4 List of Documents AML/E .....	7 -10

## 8 Index

---

# 1 Before You Work with this Manual

---

## 1.1 Explanation of Symbols and Notes

---

The following symbols and highlighted passages draw attention to important information.



Explanations of these symbols see chapter “Hazard Alert Messages” (☞ Page 1-2).







### Information

**Informationen, die für das weitere Verständnis dieser Anleitung wichtig sind.**

<KEY>	Key on the keyboard of the AMU processor
<1> + <2>	Press these keys simultaneously
“ABCD”	Headline, e. g. chapter 3 “For Your Safety” Special term, e. g. “Manage Users” Filename, e. g. “AMUINST.EXE”
<b>ABCD</b>	Terms appearing on the AMU operating console
ABCD	Command line appearing in the OS/2 input window, e. g. [C:\]cd amu
☞	Cross reference  - to a description on another page of this manual (☞ Page 1-1)  - to a description in another manual: MG (Maintenance Guide), OG (Operator Guide), IG (Installation Guide) (☞ MG 4.5.5 “Board CP/MEM4”)

### 1.2 Hazard Alert Messages

We classify the hazards in several categories. The following table shows the relation of symbols, signal words, the actual hazard, and its possible consequences.

Symbol	Damage to...	Signal Word	Definition	Consequences
	<b>People</b>	<b>DANGER!</b>	imminently hazardous situation	death or serious injury (maiming)
		<b>WARNING!</b>	potentially hazardous situation	possibly death or serious injury
		<b>CAUTION!</b>	less hazardous situation	possibly minor or moderate injury
	<b>Property</b>	<b>ATTENTION!</b>	potentially damaging situation	possibly damaging to: <ul style="list-style-type: none"> <li>• the product</li> <li>• its environment</li> </ul>
		<b>Information</b>	tips for users and other important/useful information and notes	no hazardous or damaging consequences for people or property
		-	calls attention to the address of your service contact	no hazardous or damaging consequences for people or property

### 1.3 Assistance

---



If you cannot solve a problem with the aid of this document or if you are interested in a recommendation regarding training, please contact your contract partner or the ADIC/GRAU Technical Assistance Center (ATAC).

**ADIC/GRAU Storage Systems GmbH**  
Eschenstrasse 3

**89558 Boehmenkirch**  
Germany

**We would be pleased to help you further:**

**Telefax:** +49 (0) 6196-59 08 69

**Email:** [techsup@adic.com](mailto:techsup@adic.com)

**Telephone:** 1 800 827 3822  
+49 6142 992364  
00800 9999 3822

**ADIC**  
10949 East Peakview  
avenue  
Englewood, CO 80112  
U.S.A.

**North America**  
Germany  
(the rest of the world)

### 1.4 About this Manual

---

This manual contains all information and instructions you need to operate the AMU safely. Additional important information is being called attention to where needed.

AML/E only

With a corresponding configuration AMU can be used to control various kinematics:

- AML/2
- AML/E
- AML/J

Information relating only to one specific configuration is identified by a note on the page margin (e. g. AML/E only).

You have received comprehensive training from ADIC/GRAU Storage Systems and can operate the DOC E00 005 system without endangering yourself or others.



#### **WARNING!**

**Operation of the DOC E00 005 system by untrained persons can lead to dangerous situations.**

**The consequence could be severe or fatal injury caused by moving parts or contact with live connections.**

**Introductory training at ADIC/GRAU Storage Systems therefore is an indispensable precondition for all who work with the DOC E00 005 system!**

Turn to the Operator Guide when an operating problem comes up.

If you cannot solve a problem

- consult a specialist
- call the authorized service-partner or ask ADIC/GRAU Storage Systems for assistance.

Please note however:



#### **WARNING!**

**You may carry out some work and adaptations only if you have the appropriate qualifications and training!**

**And most importantly:**

**Be sure to read chapter “For Your Safety” (☞ MG chapter 3 or ☞ IG chapter 3), before you begin working with the equipment!**



### 1.5 Copyright

---

This document is copyrighted and may not, without written permission from ADIC/GRAU Storage Systems, be copied either in whole or in part, duplicated, translated or held on any electronic medium or in machine readable form.

The DOC E00 005 system (mechanics, hardware and software) described in this document is supplied on the basis of a general licence agreement or single license (entailing the commitment not to pass it on to third parties). The software may only be used and copied as authorized by the agreement. The same applies without restriction to the entire documentation of the DOC E00 005 system. Who copies the software (AMU, handling unit) without authority onto cassettes, disks or any other storage medium is liable to prosecution.

ADIC/GRAU Storage Systems reserves the right to change or adapt the functions described in this manual without stating reasons.

DOC E00 005/2 registered trademark of  
ADIC/GRAU Storage Systems - Germany

DOC E00 005/E registered trademark of  
ADIC/GRAU Storage Systems - Germany

DOC E00 005/J registered trademark of  
ADIC/GRAU Storage Systems - Germany

CM/2 registered trademark of IBM

DB 2/2 registered trademark of IBM

IBM registered trademark of IBM

OS/2 registered trademark of IBM



## 2 About AMU

---

### 2.1 Introduction

---

#### 2.1.1 AML Management Unit (AMU)

---

AMU is

- the host computer software by ADIC/GRAU Storage Systems
- the central interface of the unmanned AML system.

AMU manages the archive catalog.

The archive is based on a DB/2 compatible database system for OS/2 by IBM. It allows to trace the condition of a storage compartment or the position of a Volser at any time.

With the appropriate configuration AMU can control various kinematics:

- AML/2
- AML/E
- AML/J

### 2.1.2 Tasks of AMU

---

- Host communication
  - interprets commands from the host
  - checks these commands for executability
- Archive catalog management
  - stores the logical coordinates of the compartments
  - assigns media to the compartments
  - keeps track of the status of compartments and drives
- Converts the logical coordinates into physical coordinates
- Communicates with
  - the robot control system
  - the storage tower control system
  - the I/O unit/A
- Operator interface
  - for initial operation
  - for the operator
  - for service
- Error messages (LOG and Trace)
- Configuration (describes the specific structure of the archive)



#### **Information**

**AMU does not register the data content of media.**

### 2.1.3 Host Connections

---

#### Normal operation

In normal operation (“AUTO” = unmanned operation) a host computer controls the system.

#### AMU as server

In environments with several hosts AMU operates as a server. It serves as overall coordinator, since several host computers can operate with the AML system in parallel. Die entsprechenden Host-Softwarekomponenten kommunizieren dabei über verschiedene Anbindungen mit der AMU.

#### Selection and number of connections

The kinds of connection for the respective host types are listed in the table below and the chart (☞ Page 2-5) in this chapter.

The number of possible parallel host connections to AMU is limited only by the AMU hardware. If the version does not provide what is required select the next higher hardware version.

The AMU hardware currently used can manage up to three host connections.

Host	Host Software
IBM - MVS	HACC/MVS
IBM - VM/VSE	HACC/VM/VSE
Siemens BS2000	ROBAR (BS2000)
IBM - AS400	HACC/OS/400
Tandem	HACC/Guardian
UNIX	HACC/DAS
DEC	HACC/Open VMS
UNIX	VolServ
UNIX	AMASS

### Limitations

In an environment with several hosts the following limitations apply

- 1 coaxial connection (EXCP / LU 2) per AMU
- 1 Token Ring connection with n x LU 6.2- and 1 coaxial connection in parallel
- simultaneous connection of HACC/MVS and HACC/VM:
  - HACC/MVS via LU 6.2
  - HACC/VM via EXCP/LU 2
  - always additionally possible is: TCP/IP via Ethernet
  - always additionally possible is: AML via RS-232-C

The dual-AMU is supported by the host software HACC/MVS as of version 2.4.0 and by ROBAR as of version 2.6.

### Connecting options

The following chart provides an overview of the various connecting options.

Fig. 2-1: Overview of Connecting Options

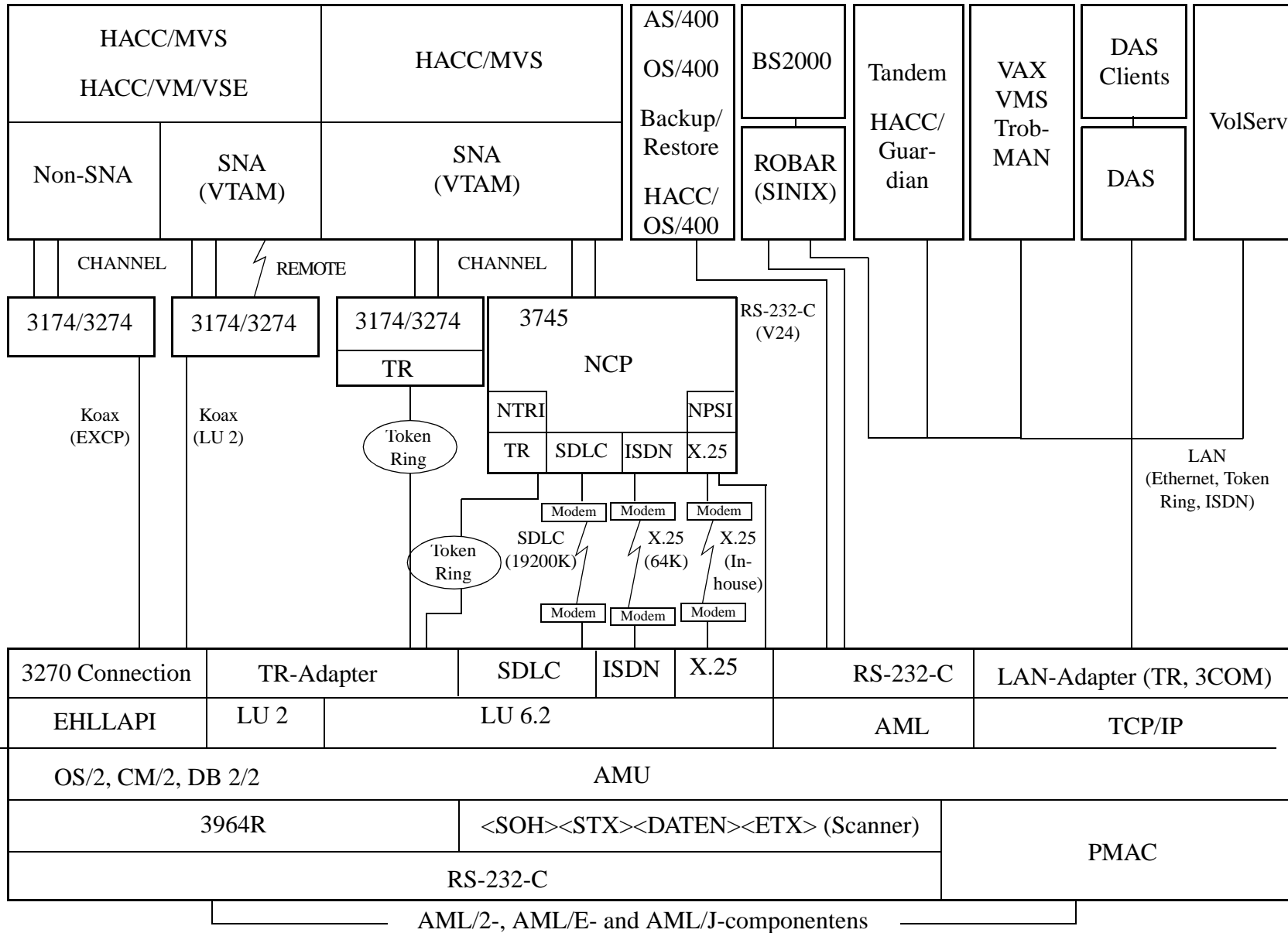

### 2.1.4 Archive Organization

---

AMU operates with a database.

This database contains the assignment of compartments (coordinates) to storage media (Volser) as well as additional information.

Such information includes

- the kind of coordinate, e. g. which type of medium can be stored at this coordinate
- the state of the coordinate, e. g.
  - is it occupied or empty,
  - has the Volser just been mounted on a drive
  - or which robot is assigned to access the coordinate
- the frequency of its use (Usecount)

#### **Hierarchical archive organization**

Most archives are organized hierarchically, that is, Volsers are assigned to coordinates in ascending sequence

In the graphic configuration areas (Volser Ranges) are defined, which are then preoccupied by data records when the database is created.

A Volser can be stored in the system only if it is within a Volser Range and therefore has a home coordinate (Home-Position).

Identification is made automatically with the aid of the barcode label on the storage medium.

Foreign media are media which are not part of the archive and which are to be processed by the AML system for a limited time.

They can be made accessible to the system via a foreign media mount area in the I/O unit.

They are not stored in the archive and therefore do not need a barcode label.



### **Dynamic archive organization**

For data processing centers with a high throughput of media a range as large as required or even the entire archive can be defined as dynamic.

If an as yet unknown Volser is to be filed in the archive it will automatically be assigned to the first vacant compartment in the dynamic range. This compartment remains the home position of the Volser until it is ejected from the system with the "Eject Total" option.

Only after total ejection the respective compartment is released for reassignment by AMU.

### **Dynamic archive organization with HACC/MVS**

The host software HACC/MVS operates with its own archive.

When a new Volser is filed in the system the target coordinate (new home position) is assigned by HACC/MVS.

This system also differentiates temporary and total ejection.

## 2.1.5 Data Safety

### Dual-AMU

The AMU plays a key roll in the connection of host systems and robot system. An AMU failure leads to a standstill of the entire robot system. To minimize the risk of such failures an additional PC (dual-AMU) may be provided.

All required software components are installed on the dual-AMU. The dual-AMU is permanently connected to the active AMU (via Ethernet, Token Ring or RS-232-C).

All actions of AMU(A) resulting in database updates are reported to the dual-AMU(B). The data records involved are then also updated in the dual-AMU. If the dual-AMU is not available for some time, the changed data records are marked in the active AMU, and are transferred to the dual-AMU as soon as the connection has been revived.

When the active AMU fails the dual-AMU can take over its full function. To allow for this, the connections to the control systems and the respective host connection(s) must be switched over. Switch-over is made by commands on the host level (☞ Documentation of host software).

The host command ROSA used in connection with an ADS (Automatic Data Switch) switches over the connection to the control units.

	<b>Dual-AMU with ADS</b>	<b>Dual-AMU with manual Data Switch</b>	<b>Dual-AMU without Data Switch or ADS</b>
AML/2	x	x	x
AML/E	x	x	x
AML/J	not available	not available	x

An ADS be used on AML/2 and AML/E.

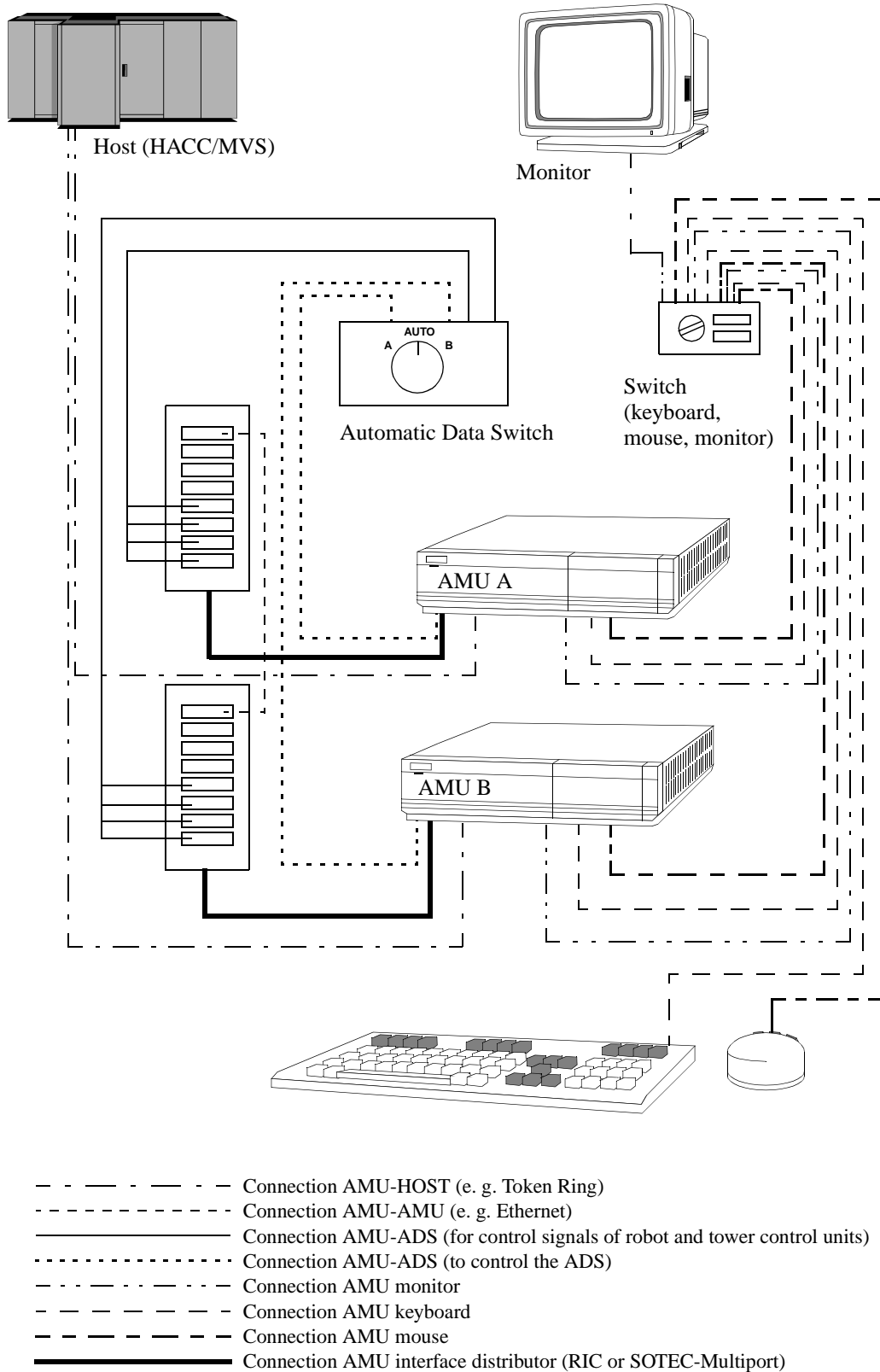

Fig. 2-2: Principle of the Dual-AMU

### Database backup (AMU version 2.0 or higher)

Independent of the dual-AMU a constant, up-to-date backup of the database can be created: the database backup (☞ **Process Configuration** bzw. **Database Backup**).

The database backup function is switched on or off with an entry in the configuration file AMUCONF.INI (QVW Abb. 3-43).

- in AMU 2.0 in the configuration file AMUINI.INI
- in AMU 2.2 or higher in the configuration file AMUCONF.INI

With an entry in the configuration file you can also determine where the backup and journal files will be stored.

You can write these files

- to a second physical harddisk in the AMU PC
- via the IBM-LAN-Requester to a LAN server (accessory). This would also provide protection from possible disk crashes.

The database backup starts once per day: when AMU is free (“Idle Time”) at an adjustable time.

The backup runs as an independent task in the background, that is while the system operates.

All data records in the database are written to an ASCII file in their entirety (complete backup). Additionally all current changes are protocolled in separate files (journal files).

Since the database backup is created outside the database system, it will remain available for restoration even if the database manager fails.

You can completely restore a database. To do that the following is required

- the backup file,
- the corresponding journal files and
- the **Restore** command in the AMU **Service** menu (QVW S. 3-50).  
During the restoration the backup and journal files are checked for integrity.

---

### 2.1.6 Disaster Recovery Support

---

After a failure of the entire data processing center (host and disk storage) some media are immediately required from the archive, to be able to continue operating with a spare data processing center (Disaster Recovery). Since the host and the software required for control of the AML system is no longer available in such a situation, output is made via AMU (QVW S. 4-37).

## 2.2 Hardware

---

### 2.2.1 Basic Configuration

---

- 486 DX2 66 Mhz
- harddisk storage: minimum 500 MB
- main storage: 16 MB
- monitor 14" SVGA
- keyboard (selectable: German/American English/French)
- mouse
- mouse pad
- cable

### 2.2.2 Accessories

---

- printer
- modem (Bocamodem 14.4 Kbps V.32 External Modem)
- dual-AMU:
  - the configuration of the dual-AMU is identical with the basic configuration (without monitor, keyboard, mouse, and modem) plus
  - "DataSwitch T-Switch" (monitor + keyboard + mouse)
  - Automatic Data Switch (ADS) or manual data switch

### 2.2.3 Interfaces

---

- host computer
- robot control
- storage tower control
- I/O unit/A
- dual-AMU
- modem

**2.2.4 Adapter Boards**

The specific configuration of the system determines which adapter boards are required. The configuration is part of your acknowledgement of order.

Adapter Board	Connection
Dual ASYNC Adapter	interface extension (2x)
IBM-RIC-board (Realtime Interface Coprocessor)	interface extension (8x)
SOTEC-Multiport	interface extension
Token Ring Adapter 16/4	Token Ring <ul style="list-style-type: none"> <li>• TCP/IP</li> <li>• LU 6.2 (APPC)</li> <li>• LU 2 (EHLL)</li> </ul>
coax board 3270 Connection	coax <ul style="list-style-type: none"> <li>• LU 2 (3270) (EHLL)</li> <li>• EXCP (3270)</li> </ul>
Etherlink board 10BASE-T 10BASE-2 10BASE-5	Ethernet <ul style="list-style-type: none"> <li>• TCP/IP</li> <li>• LU 6.2 (APPC)</li> <li>• LU 2 (3270) (EHLL)</li> </ul>
ISDN-Adapter	ISDN <ul style="list-style-type: none"> <li>• TCP/IP</li> <li>• LU 6.2</li> </ul>
X.25 coprocessor	X.25 (Datex-P) <ul style="list-style-type: none"> <li>• LU 6.2</li> <li>• LU 2</li> </ul>
SDLC-Adapter	SLC <ul style="list-style-type: none"> <li>• LU 6.2</li> </ul>

### 2.2.5 Media

---

You may select from the following types of media:

- D2 small (25 Gbyte magnetic tape cartridges)
- D2 medium (75 Gbyte magnetic tape cartridges)
- magnetic tape cartridges 3480, 3490 and 3490E
- magnetic tape cartridges TK-85 (Digital Linear Tape)
- magnetic tape cartridges (type Exabyte 8 mm)
- magnetic tape cartridges (type 4 mm) DAT (Digital Audio Tape)
- magnetic tape cartridges 3590 (NTP)
- Optical Disks 9 mm (type Reflexion)
- Optical Disks 11 mm (type 512)
- VHS cassettes
- TRAVAN
- DTF Small
- DTF Large
- BetaCAM
- CD-ROM (Caddy)

You can store different types of media in one storage unit.

- the smallest unit is 1 segment
- ranges with the same type of media must be defined together in one component

## 2.3 Software

---

### 2.3.1 Operating System OS/2 Version 3.0 WARP English

---

OS/2 Version 3.0 Warp englisch

### 2.3.2 Communications Manager/2 Version 1.1

---

Communications Manager/2 = CM/2

You must install LAPS (LAN Adapter and Protocol Support) for

- all Token Ring/LU 6.2 applications such as
  - AMUL62P
  - AMUL62PC
  - AMUL62S
  - AMUL62SC
- Ethernet/TCP/IP

### 2.3.3 Database Manager 2 (Single-User) Version 2.1.1

---

Database Manager 2/2 = DB 2/2



2.3.4 AML Management Unit Software

AML Management Unit Software = AMU Software

The software consists of individual programs (processes) running in parallel (multi-tasking). Each process accomplishes a specific task. Additionally there are various service utilities.

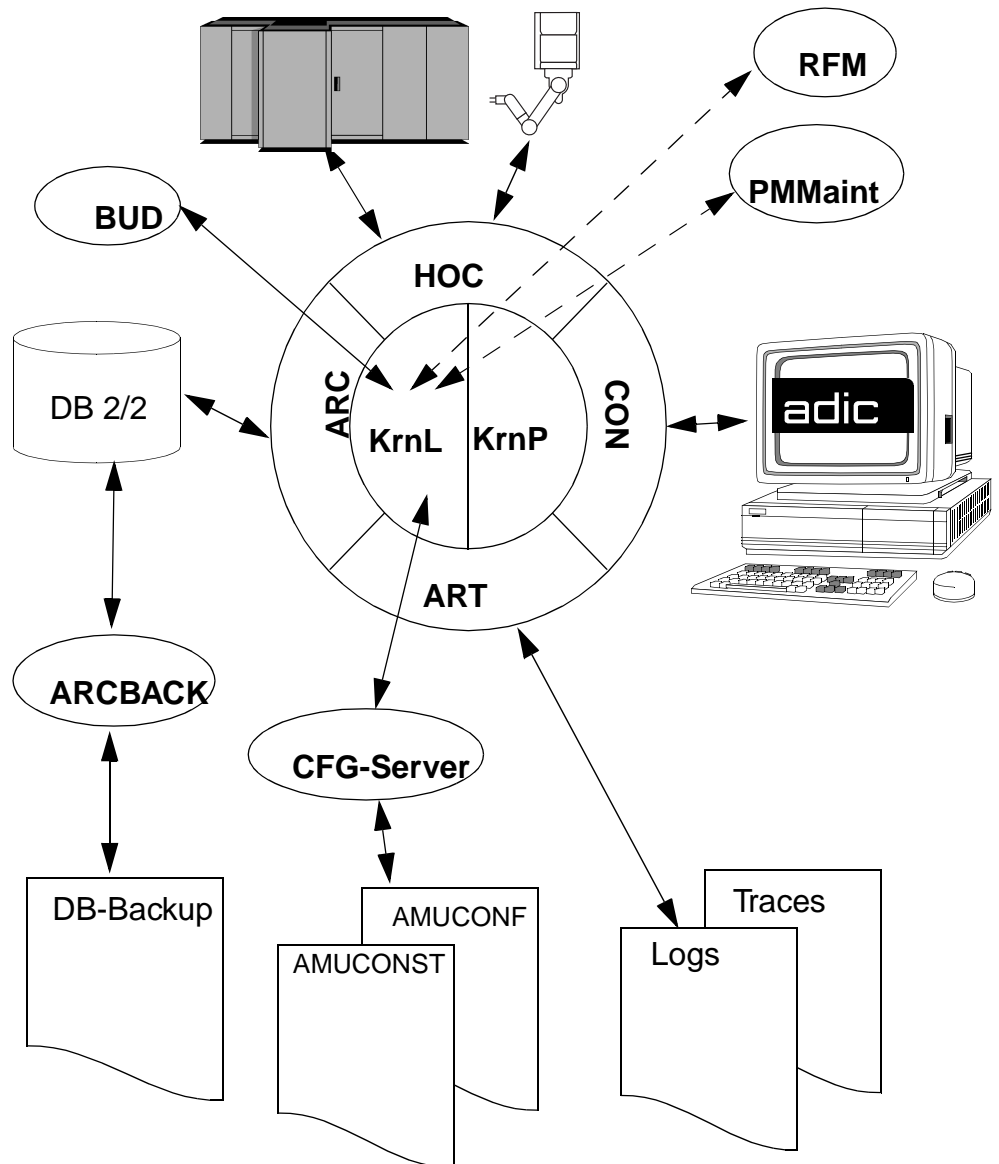

Fig. 2-3: Processes of AMU

- **ARC (ARChive)** management of the archive catalog (journaling); SQL data base
- **ARCBACK (ARChiv-BACKup)** writes backup file
- **ART (AleRTer)** writes logs and traces
- **BUD (BackUp Daemon)** resident process controlling the data communication between the dual-AMUs
- **CON (AML Operator CONsole)** operating console for operation, installation and maintenance
- **HOC (HOst Communication)** communication with
  - host computers
  - control system of robot
  - control systems of storage towers
  - control systems of I/O units/A
- **KRN (KeRNel)** central logic, converts host commands into control commands for the robot (computes coordinates)
- **RFM (Rho File Manager)** data transfer to the rho control system when Kernel, HOC and ARC (incl. DB 2/2) are stopped

### 2.4 AML Coordinates (ABBA/1 Format)

---

The ABBA/1 format is used with the following host software:

- HACC/MVS
- HACC/VM/VSE
- ROBAR
- HACC/Guardian

#### 2.4.1 Volser in an Archive with ABBA/1 Host Communication

---



##### Information

**Host system operating with the AMU using the ABBA/1 format must exclusively process command with 6-digit volsers. During input and inventories in multi-host systems be sure to adhere to the proper ranges from I/O unit, archive.**

#### 2.4.2 Comparing AMU and Host Coordinates

---

All target locations of the system which can house media are described by logical coordinates.

These logical coordinates are converted by the AMU software into physical increments counted from a zero-point (x-, y-, z-axis).

#### 2.4.3 Structure

---

AMU converts the logic coordinates from the host computer into AMU coordinates.

**Storage towers**

Host computer

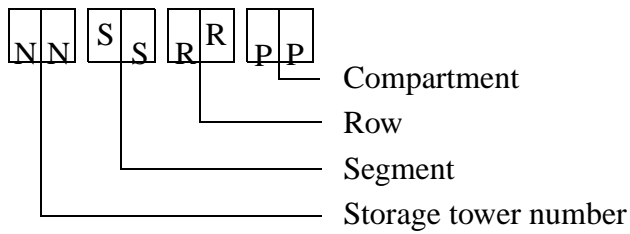

AMU

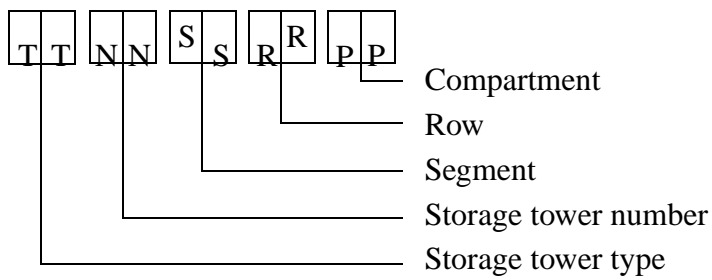

**Linear shelves**

Host computer

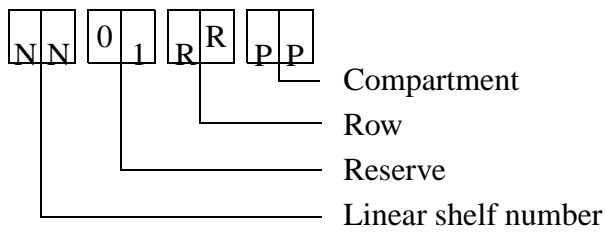

AMU

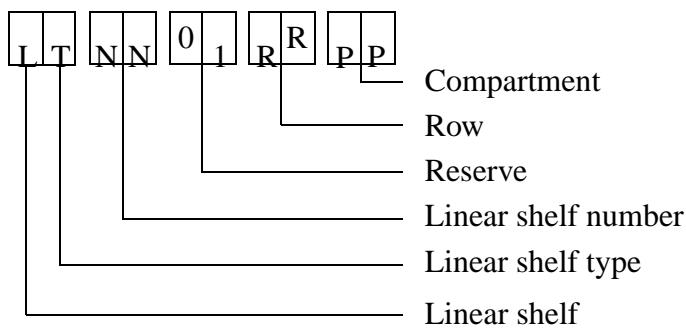

**2.4.4 Archiv Coordinates**

---

Storage towers (Quadro towers, Hexa towers, Linear shelves)

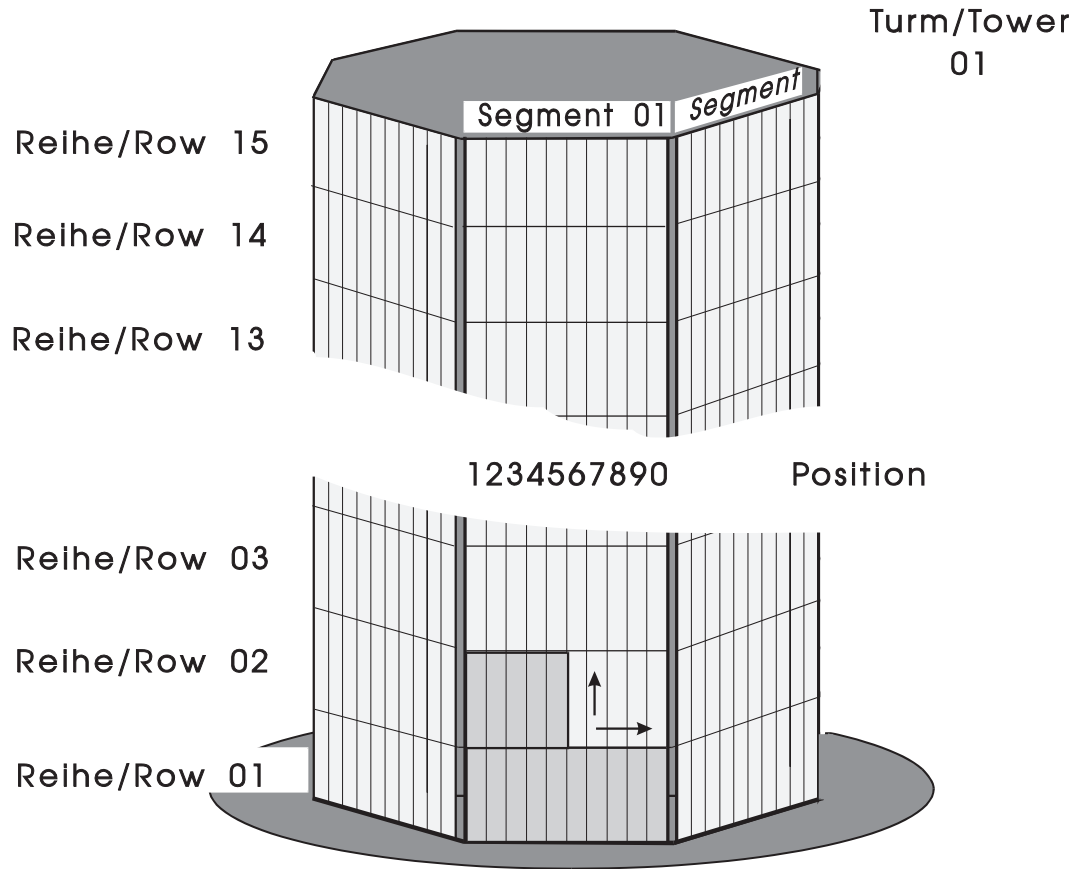

*Fig. 2-4: Numbering of Coordinates Row by Row*

2.4.5 Special Coordinates

**I/O units**

Each robot in an AML/2 system has an I/O unit.

The I/O unit has ranges for

- input
- output
- foreign media

AMU

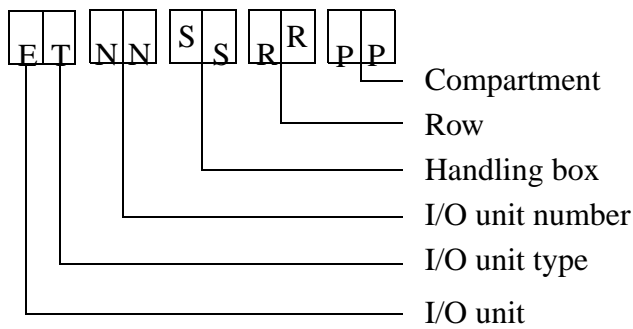

Host computer input range (e.g. 00 01 03 10)

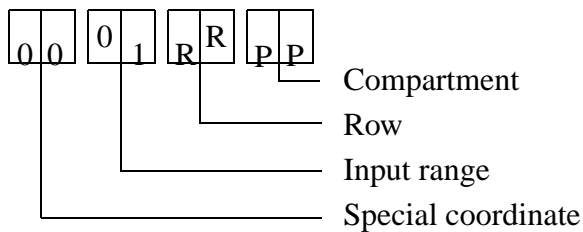

Host computer output range (e.g. 00 02 05 01)

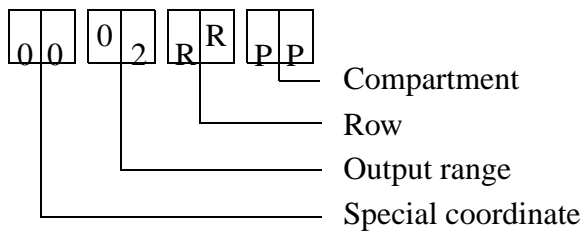

## AML Coordinates (ABBA/1 Format)

Host computer foreign media range (e. g. 00 03 06 01)

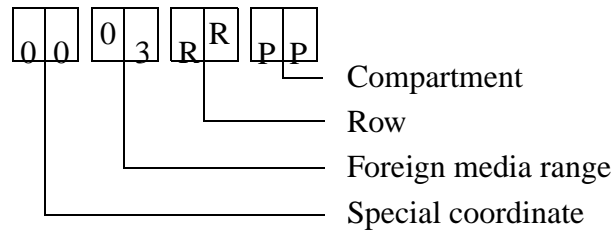

### Drives

AMU (z. B. D9 04 01 01 01)

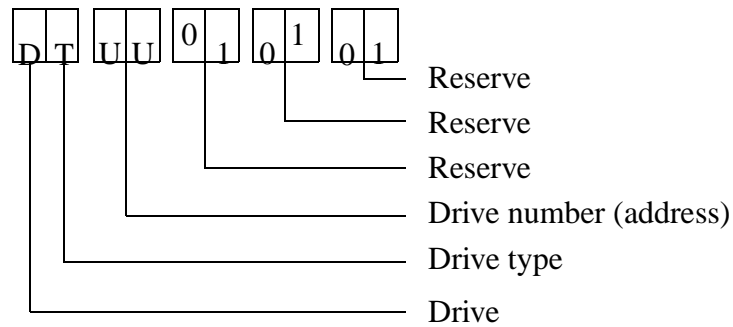

Host computer (z. B. 00 00 04 01)

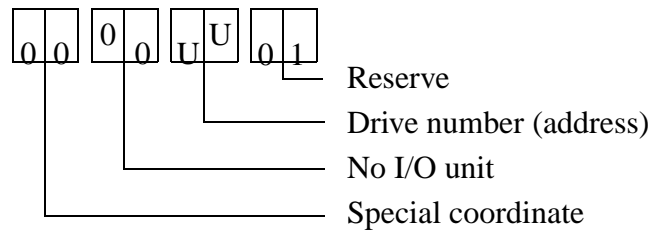

Example: AMU "D9 04 01 01 01" = host computer "00 00 04 01"

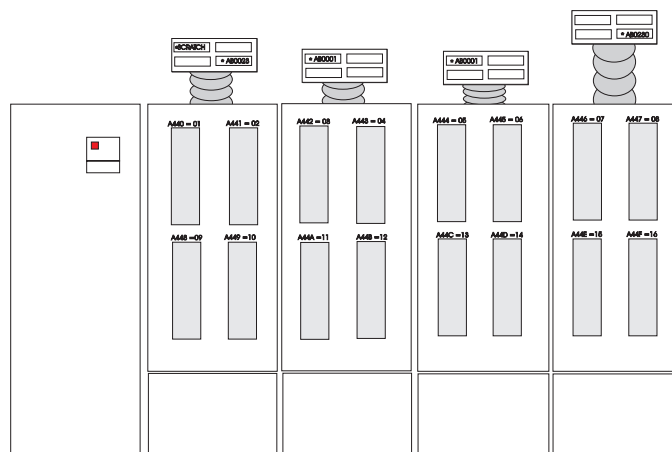
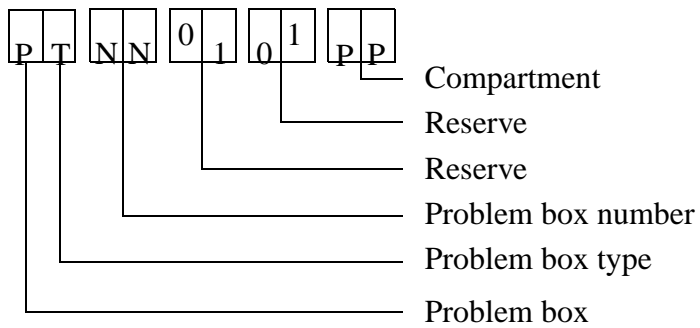

Fig. 2-5: Count Mode for Drives

**Problem box**

AMU



Host computer (e.g. 00 00 00 01)

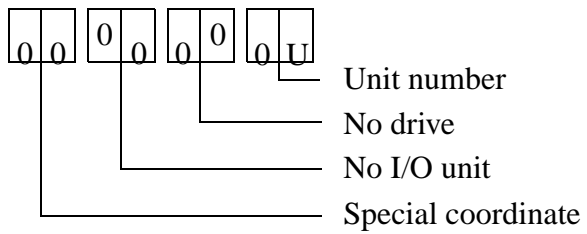



### 2.4.6 Status of Coordinates

---

In the communication protocol the host computer uses abbreviations for the status and the type of compartments.

<b>HOST - Logic Status</b>	<b>AMU - Coordinate Type</b>
M - Magnetic tape	<b>S</b> - Storage
O - Optical Disk	<b>S</b> - Storage
C - Cleaning cartridge	<b>C</b> - Clean
0 - Special status	

<b>HOST - Physical Status</b>	<b>AMU - Coordinate Attribute</b>
B - in storage tower or in drive	<b>0</b> - Occupied
E - Ejected	<b>E</b> - Ejected
M - Mounted	<b>M</b> - Mounted
L - Initial (only for special status)	<b>Y</b> - Empty

Examples for status display

(display at the host computer console or in AMU trace):

- empty compartment in archive                    **OL**
- compartment in tower during mount           **MM**
- occupied compartment in archive            **MB**
- compartment for cleaning cartridge in tower **CB**
- compartment for cleaning cartridge  
during clean mount                               **CM**
- compartment in archive for ejected medium **ME**



### 3 Operating Console

---

Instructions input via the operating console of the AML system (AMU operating console) have the same priority as host instructions.



#### **ATTENTION!**

**Especially when using the commands Put, Get, Look, and Teach, be sure to prevent conflicts with host commands.**

**If in doubt, restart the AMU after using any of these commands.**

**If the configuration has been changed AMU must be restarted.**

Input at the AMU must be restricted to the following situations:

- host communication failure (“AUTO”)
- robot failure (manual update of the archive catalog after manual interventions (☞ Operator Guide))
- during installation
- during maintenance



#### **Information**

**All non-executable commands or options are displayed with a shadow.**

#### 3.1 Operation

---

Layout and operation conform to SAA standards.

It is controlled by

- the keyboard
- the mouse

Further information is found in the OS/2 manuals.

3.1.1 Window Layout

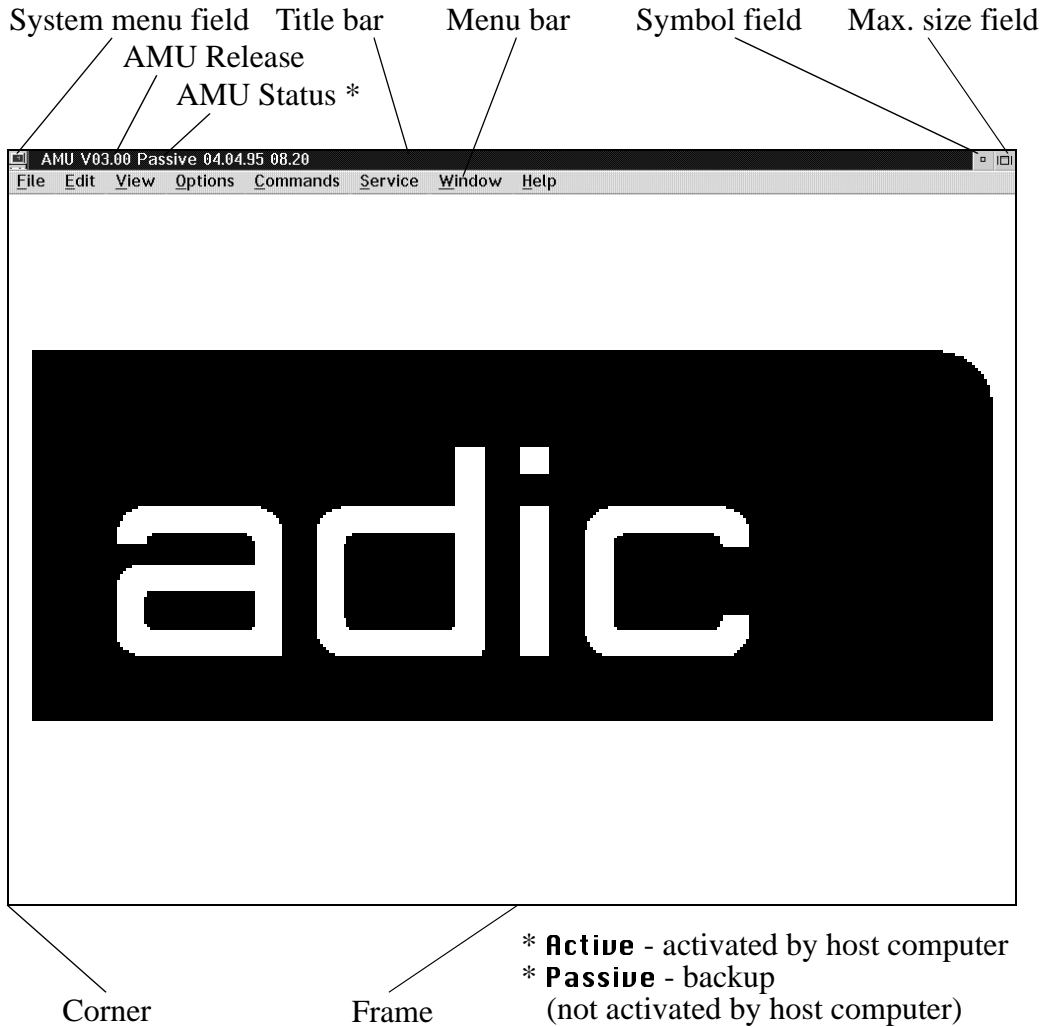



Fig. 3-1: Window Layout of Operating Console



**Information**

**When the window is active the title bar has a green background. When the window is inactive the title bar has a gray background.**

The following functions are the same in all windows:

Button	Function
	Cancels the current function and closes the window.
	Opens online help.

### 3.1.2 Selecting a Command

---

#### With the mouse

- a) Move the mouse pointer to the desired menu in the menu bar.
- b) Click on the menu; the menu opens.
- c) Click on the command in the menu; the command window opens.

#### With the keyboard

- a) Press the <ALT> key and the underlined letter in the menu bar. The menu opens.
- b) Now press the underlined letter in the menu to select the command.

#### With a command code

If a key or a combination of keys is specified following the command you can directly select the command with it.

### 3.1.3 Altering a Window's Size

---

Resizable windows have a frame all around (e. g. Trace window).

- a) Move the mouse to any corner of the active window.  
The mouse pointer changes into a double arrow.
- b) Press the mouse button and pull the window to the desired size while keeping the mouse button pressed.

### 3.1.4 Moving a Window

---

- a) Move the mouse pointer onto the title bar.
- b) Move the window while keeping the mouse button pressed.

### 3.1.5 Closing a Window

---

Close the window by a double click on the system menu field.

### 3.2 Overview of Menus

All commands of the operating console are explained below.

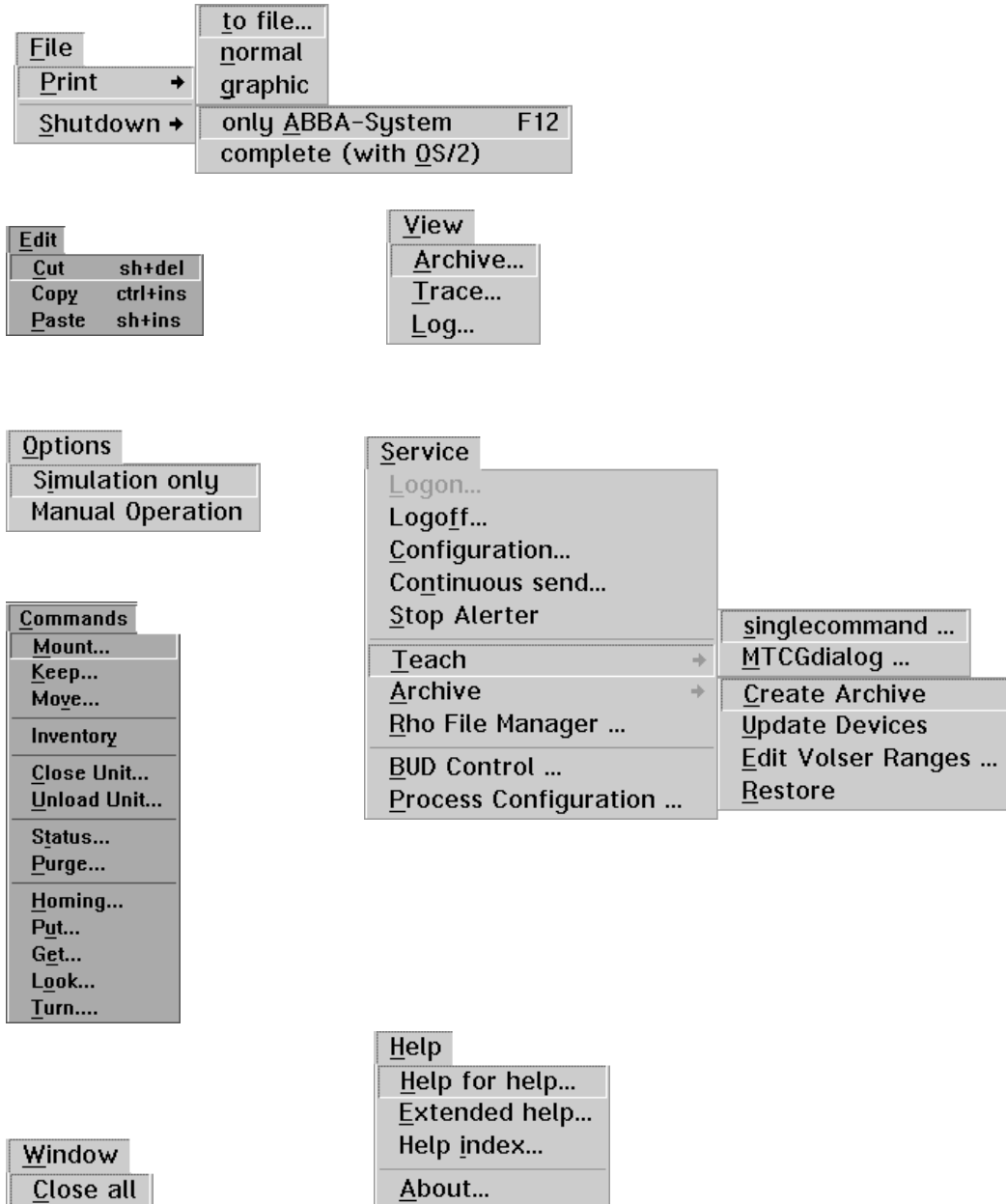

Fig. 3-2: Overview of AMU Menus

### 3.3 Menu File

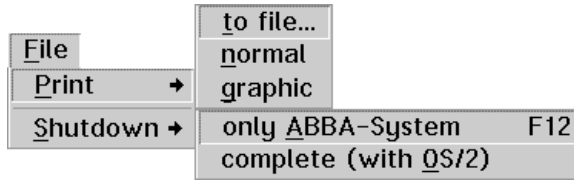

Fig. 3-3: Menu "File"

Command	Field	Explanation
Print		Print selected lines from the log data.



**Information**

First select the lines to be printed in the LOG Control Center.

... to file

Store as a text file.

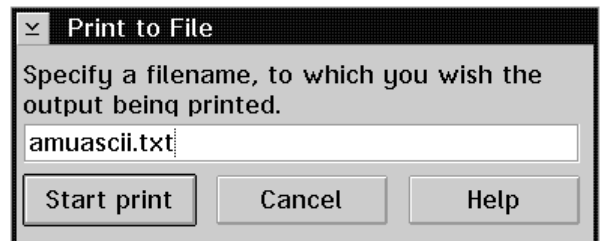

Fig. 3-4: Window "Print to File"

Enter the target file name with path (e.g. a:\logascii.txt).

**Start print** starts the filing.

... normal

Print with standard font.

... grafic

Print with graphic font.

Command	Field	Explanation
Shutdown only AML system	Prepares shut-down of the AML system.	
		

Fig. 3-5: Window "SHUTDOWN OF AML"



**ATTENTION!**

Before shutting down interrupt the communication with the host computer (e.g. with HOLD 1,1).

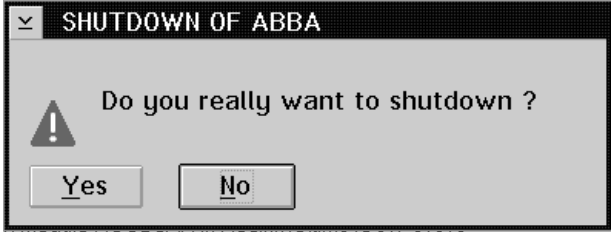
**Yes**

The current command will still be processed. After that, all modules of the AMU will be terminated and the database will be closed.



**Information**

Shutting down of the system  
 ➔ Operator Guide.

**No**

Return to the program, no shut-down.



Command	Field	Explanation
<b>Shutdown complete (with OS/2)</b>		Prepare shut-down of the AML system (like Shutdown only AML system) and then terminate all processes running under OS/2 and terminate OS/2.

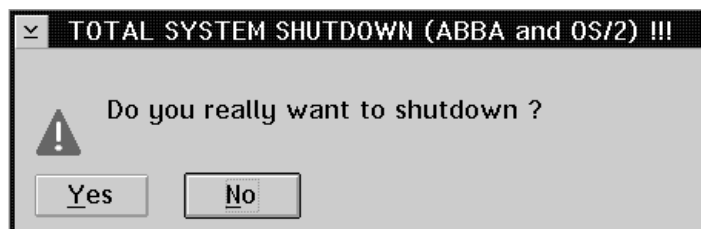

Fig. 3-6: Window "TOTAL SYSTEM SHUTDOWN"



### ATTENTION!

**Before shutting down interrupt the communication with the host computer (e.g. with HOLD 1,1).**

## 3.4 Menu Edit

---

<b>Edit</b>	
<b>C</b> ut	sh+del
<b>C</b> opy	ctrl+ins
<b>P</b> aste	sh+ins

Fig. 3-7: Menu "Edit"

<b>Command</b>	<b>Explanation</b>
<b>Cut</b>	Cut the marked object and file it in the intermediate storage (computer main storage).
<b>Copy</b>	Copy the marked object to the intermediate storage.
<b>Paste</b>	Insert the object from the intermediate storage at the current cursor position.

### 3.5 Menu View



Fig. 3-8: Menu "View"

Calls up information in various windows.(continued)

Command	Field	Explanation
Archive...		Check and change entries for specific compartments in the archive catalog.  After input of information (e.g. volser) the respective archive catalog entry is displayed.

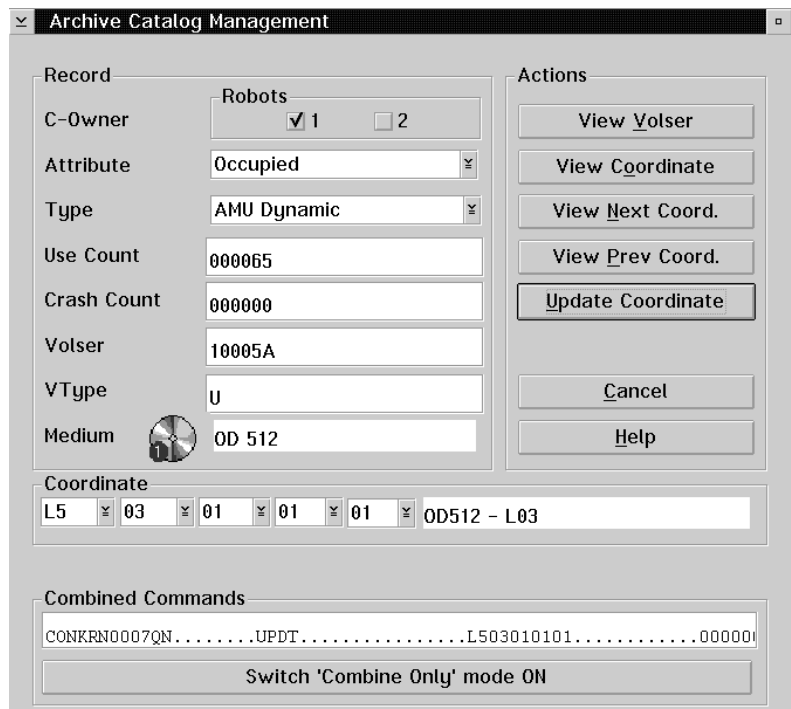





Fig. 3-9: Window "Archive Catalog Management"

Command	Field	Explanation
Archive...	<b>C-Owner</b>	Medium owner: indicates the robot or the robots which can access this medium.
	<b>Attribute</b>	<p>Status of the medium</p> <ul style="list-style-type: none"> <li>• <b>Occupied:</b> compartment occupied</li> <li>• <b>Ejected:</b> medium has been ejected</li> <li>• <b>Mounted:</b> medium mounted on drive</li> <li>• <b>Initial:</b> initial attribute condition (initialized, available)</li> <li>• <b>In Jukebox:</b> medium in jukebox</li> <li>• <b>Reverse Side Mounted (OD only):</b> medium mounted in drive (reverse)</li> <li>• <b>Empty:</b> compartment empty</li> <li>• <b>Undefined:</b> not defined</li> <li>• <b>Temp Away:</b> attribute not occupied (no home position)</li> <li>• <b>Temp Here:</b> medium in the problem box</li> </ul>
	<b>Type</b>	<p>Type of compartment in the archive</p> <ul style="list-style-type: none"> <li>• <b>Storage:</b> archive compartment for <ul style="list-style-type: none"> <li>- hierarchically defined Volser ranges</li> <li>- dynamically defined Volser ranges, on HACC/MVS only</li> <li>- no cleaning medium compartment</li> </ul> </li> <li>• <b>Clean:</b> cleaning medium compartment</li> <li>• <b>AMU-Dynamic (not on HACC/MVS):</b> archive compartment for dynamic insert and transit</li> </ul> <p>Type of compartment in the I/O unit</p> <ul style="list-style-type: none"> <li>• <b>Foreign:</b> foreign media compartment</li> <li>• <b>Problem:</b> compartment in the problem box (I/O unit)</li> <li>• <b>Clean:</b> cleaning media compartment</li> <li>• <b>HACC-Dynamic</b> archive compartment for dynamic use of the I/O unit under HACC/MVS</li> <li>• <b>AMU-Dynamic :</b> archive compartment for dynamic use of the I/O unit under DAS, VolServ and OS400, eject range for ROBAR and optical disk compartment on HACC/MVS</li> </ul>
	<b>Use Count</b>	Number of accesses to compartment.

Command	Field	Explanation
Archive... (continued)	<b>Crash Count</b> (in preparation)	Number of times compartment is accessed without success. When the crash sensor on the gripper is activated the counter increments by one.
	<b>Volser</b>	Media number
	<b>UType</b>	Volser type of storage media <ul style="list-style-type: none"> <li>• <b>U</b>: undefined (no scratch medium)</li> <li>• <b>S</b>: scratch medium</li> </ul>
		<div style="display: flex; align-items: center;">  <div> <p><b>Information</b></p> <p><b>The value of this file can be changed only with a host command.</b></p> </div> </div>
	<b>Medium</b>	Type of medium <ul style="list-style-type: none"> <li>• <b>all media</b>: special type for problem box</li> <li>• <b>undefined</b>: reserved for special applications</li> <li>• <b>3480-1/2inch C0</b>: magnetic tape cartridges 3480 and 3480E</li> <li>• <b>TK85 C1</b>: magnetic tape cartridge TK</li> <li>• <b>3590 C2</b>: magnetic tape cartridge NTP</li> <li>• <b>OD Reflexion O0</b>: optical disk 9 mm</li> <li>• <b>OD 512 O1</b>: optical disk 11 mm</li> <li>• <b>VHS V0</b>: VHS cassette</li> <li>• <b>Exabyte 8 mm V1</b>: magnetic tape cartridge</li> <li>• <b>Exabyte 4 mm V2</b>: magnetic tape cartridge</li> <li>• <b>D2 (25 Gbyte) V3</b>: magnetic tape cartridge</li> <li>• <b>D2 (75 Gbyte) V4</b>: magnetic tape cartridge</li> <li>• <b>TRAVAN V5</b>: 3MTR-*magnetic tape</li> </ul>
	<b>View Volser</b>	Display the archive catalog entry for the volser entered.
	<b>View Next Coord.</b>	Display the archive catalog entry of the next coordinate of the component. When the last coordinate has been reached no scrolling occurs.

Command	Field	Explanation										
Archive... (continued)	<b>View Prev. Coord.</b>	Display the archive catalog entry for the previous coordinate of the component. When the first coordinate has been reached no scrolling occurs.										
	<b>View Coordinate</b>	Display the archive catalog entry for the logic archive coordinate entered.										
	<b>Update Coordinate</b>	 <p><b>Information</b> <b>This command requires login.</b></p> <p>Update the archive catalog entry for the archive coordinate.</p>										
		 <p><b>ATTENTION!</b></p> <p><b>The existing entry in the archive catalog will be overwritten. Wrong entries can lead to discrepancies between the archive and the HACCP/ MVS archive catalog.</b></p>										
	<b>Coordinate</b>	<p>Logic coordinate of the medium in the archive.</p>  <p><b>Information</b> <b>One optical disk occupies 2 logic coordinates, one for each side.</b></p> <p>The digits of the coordinates indicate the following:</p> <div style="display: flex; align-items: center;"> <table border="1" style="border-collapse: collapse; text-align: center; margin-right: 10px;"> <tr> <td>T</td><td>T</td> <td>N</td><td>N</td> <td>S</td><td>S</td> <td>R</td><td>R</td> <td>P</td><td>P</td> </tr> </table> <div style="margin-left: 10px;"> <p>— Compartment</p> <p>— Row</p> <p>— Segment</p> <p>— Device-No.</p> <p>— Device type</p> </div> </div>	T	T	N	N	S	S	R	R	P	P
T	T	N	N	S	S	R	R	P	P			

List of all device types (☞ Page 7-4)

Command	Field	Explanation
<b>Archive...</b> (continued)	<b>Combined Commands</b>	Generate a <b>Continuous Send</b> command. (☞ Page 3-45)
	<b>Switch 'Com- bine Only' mode ON/OFF</b>	Display active mode. Switch over the mode by clicking. <ul style="list-style-type: none"><li>• <b>mode ON</b>: The command string is combined and executed.</li><li>• <b>mode OFF</b>: The command string is combined but not executed.</li></ul>

Command	Field	Explanation
Trace...		Online or offline record of the internal operations of the AMU-Software. The records can be selected by levels (AMU processes). A list of the trace levels is found at the end of this chapter (☞ Page 3-97).

Trace levels can be selected with the <SPACE> bar or the mouse.



**Information**

**The selection of trace can slow down the processing!**

**Change the selection only after consulting ADIC/GRAU Storage Systems (Support). Standard selection: no traces.**



**ATTENTION!**

**The memory for the current trace is limited. When failures occur file the trace as soon as possible.**

**Trace:** Write the current traces to the main storage (1 MB reserved) and display them on the monitor. When the storage is full the oldest entry is overwritten.

**Online**

**ON**

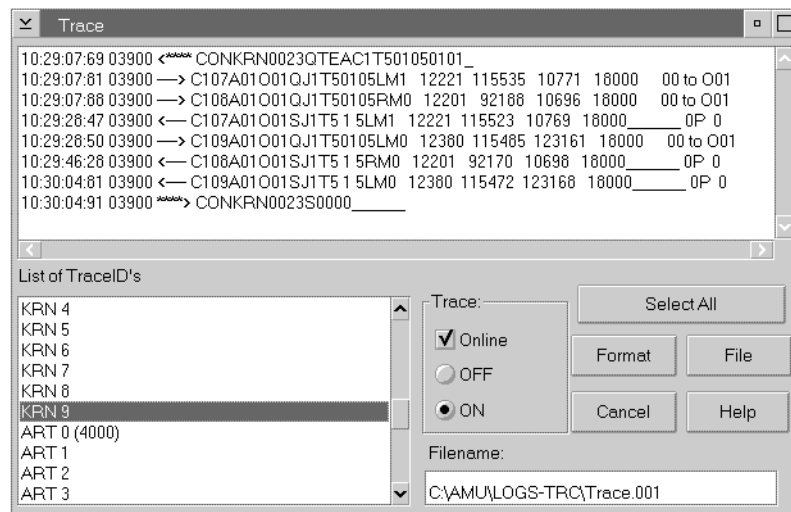

Fig. 3-10: Window "Trace" Online



Command	Field	Explanation
Trace... (continued)	Trace: ON	Save the current trace in a file in the main storage (Offline Trace).

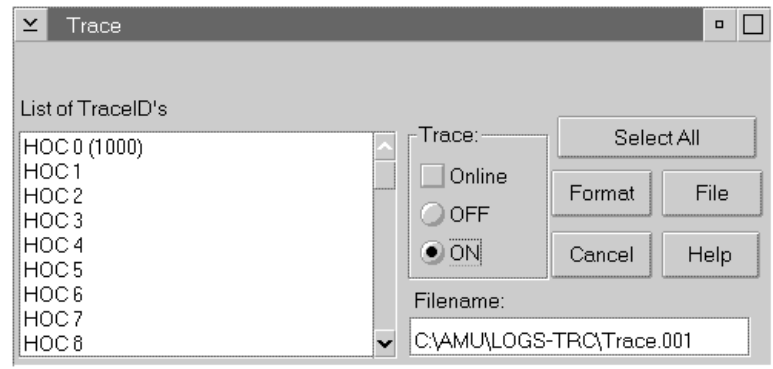

Fig. 3-11: Window "Trace" Offline

**File** File the recorded trace.

After formatting, this file can be printed (→ **Format**) with the OS/2 Print command.

**Format** Format a file saved with the **File** command for printing.

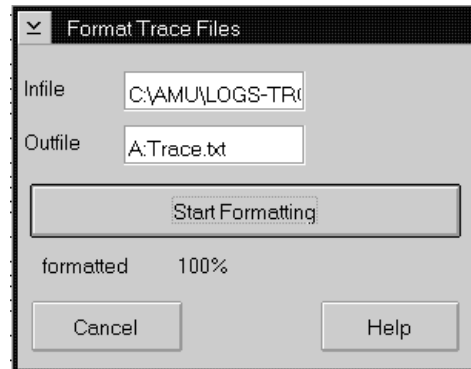

Fig. 3-12: Window "Format Trace Files"

**Infile:** source file name with path

**Outfile:** target file name with path  
(e. g. **a:\name**  
or **c:\amu\logs-trc\name**)

**Start Formatting** starts the formatting. The execution will be confirmed by display of the message "**formatted 100%**".

Command	Field	Explanation
Log...		<p>The LOG control center records all messages, e.g. (even when the LOG Control Center is not open).</p> <p>Examples:</p> <ul style="list-style-type: none"> <li>• host computer commands</li> <li>• execution of host commands</li> <li>• messages to the host computer</li> <li>• operator interventions</li> <li>• error messages</li> </ul> <p>Log files begin daily at 0.00 hours. If disk space available drops below 30 MB, the oldest log file will be deleted.</p>



**Information**

**Log files cannot cover several days!  
There is only one log file for each day.**

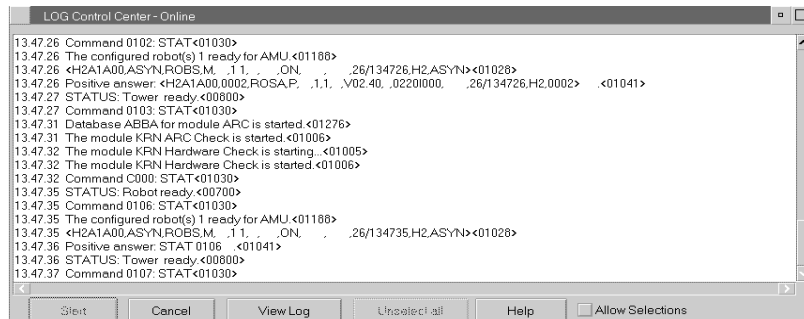

Fig. 3-13: Window “LOG Control Center - Online”

Information to to single LOG messages (☞ Page 6-4)

**Start** reserved for futher use.

**Unselect all** Delete all marks in the list box.

## Menu View

---

Command	Field	Explanation
Log... (continued)	✓ <b>Allow selections</b>	Switch enabling selection of log strings for printing or filing.  Select the desired range (only one range possible).
	<b>ViewLog</b>	<b>ViewLog</b> (scroll and search in current and stored logs)
LogView	<b>View</b>	Open the OS/2 standard Editor with the selected log-file
	<b>Exit</b>	<b>Closed the window LogView.exe</b>



*Fig. 3-14: Window „LogView.exe“*

### 3.6 Menu Options

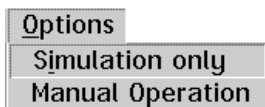



Fig. 3-15: Menu “Options”

Command	Field	Explanation
Simulation only ✓		<p><b>ATTENTION!</b></p> <p><b>Command execution alters the archive catalog although no medium is actually moved.</b></p> <p>Switch for simulation mode: No processing of commands outside AMU. AMU processes the commands as far as possible and confirms their execution to the host (positive acknowledgement).</p>

Command	Field	Explanation
<b>Manual Operation</b>	Precondition:	"MANUAL" operating mode
		Manual execution of the host commands <b>Mount</b> (montieren) and <b>Eject</b> (output) by the operator.



**Information**

**AML/2 twin systems cannot run automatically and manually at the same time.**

- a) Close all guard doors of the quadro towers. The quadro tower rotates, the robot does not move.
- b) Open the guard door and remove the medium.
- c) If a **Mount** command has been received mount the medium on the drive indicated.
- d) Confirm the execution of the command displayed with **OK**.
- e) The host computer acknowledges the execution and displays the next command.

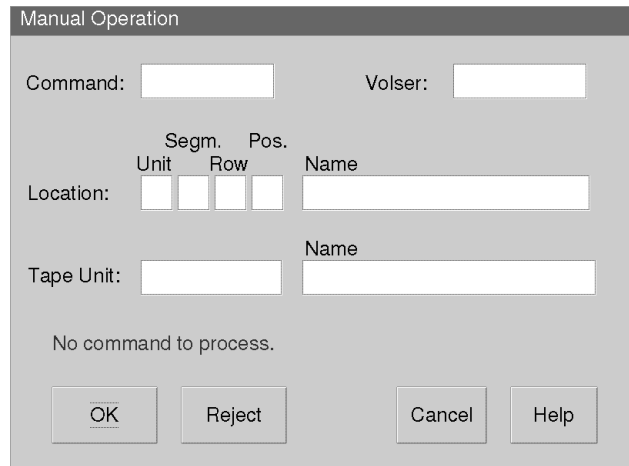

Fig. 3-16: Window "Manual Operation"

- OK** Select it when the command has been executed by the operator.
- Reject** Select it when the command will not be executed by the operator.

## 3.7 Menu Commands

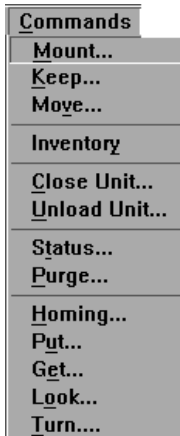

Fig. 3-17: Menu "Commands"

The commands of the commands menu are accessible only after successful **Logon** in the service menu.

All commands in this menu open the command window.



### Information

**Information not required for execution of a specific command appears shaded in the command window.**

**You can open several command windows at the same time.**



### ATTENTION!

**All AMU commands in the commands menu are designed for test and initial operation. Automatic operation is controlled by the host computer.**

**In HACC/MVS systems the archive catalog of the host computer remains unchanged when these AMU commands are used. Improper use can result in discrepancies in the archive catalogs.**

## Menu Commands

---

The following functions are identical in all command windows:

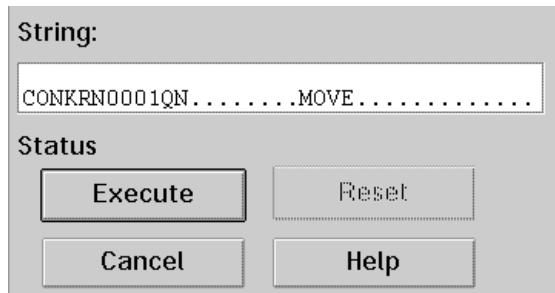

Fig. 3-18: Window "Command"

Field	Explanation
<b>String:</b>	Display command string (☞ command string convention see below)
<b>Status</b>	Display messages, e. g. <b>Cmd sent, rc 0</b> rc = Return Code: <ul style="list-style-type: none"><li>• <b>0</b> = COMMAND in execution</li><li>• <b>KRN response OK</b>: command execution successfully completed</li><li>• otherwise error number, e. g. <b>error from KRN 1033</b> (☞ Page 6-1)</li></ul>
<b>Execute</b>	Execute command
<b>Reset</b>	Terminate command transfer

### 3.7.1 Command String Conventions



**Information**

The command string may contain fill characters “.” (Default).

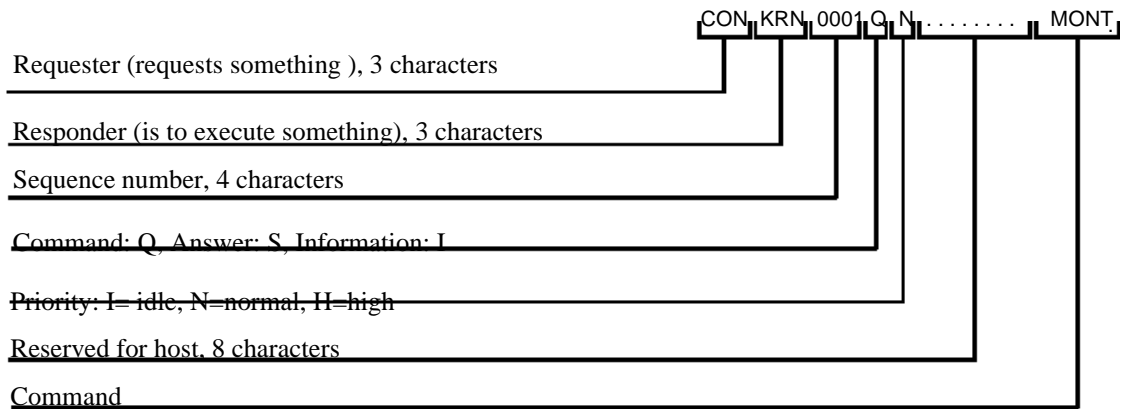

Fig. 3-19: Command String Convention Part 1

AAAAAAAAAA123456 . . . . . D902010101 .. 00000000

Volser: 16 characters

First coordinate (Source Coordinate), 10 characters

Second coordinate (Target Coordinate), 10 characters

Option, 2 characters

Length of data, 8 characters

Data

Fig. 3-20: Command String Convention Part 2



### 3.7.2 Command “Mount...”

---

Mount the medium with the Volser indicated on the drive specified.

Command - MONT

Command: MONT

Volser: 081500

Source:

Target: D01

Option:

Data:

String:

CONKRN0014QN.....MONT.....081!

Status

Execute Reset

Cancel Help

Fig. 3-21: Window “Command - MONT”

Field	Explanation
<b>Command</b>	Selected command: <b>MONT</b>
<b>Volser</b>	Enter: <ul style="list-style-type: none"><li>• Volser of the medium (e. g. <b>123456</b>)</li><li>• <b>CLEAN</b> (for first defined medium of type Clean)</li><li>• symbolic Volser (e. g. <b>*F0001</b>) for foreign medium</li></ul>
<b>Target</b>	Enter the target coordinates of the drive or the drive name (e.g. <b>D01</b> ).

### 3.7.3 Command “Keep...”

Empty the specified drive and return the medium to its home position or the compartment indicated.



Fig. 3-22: Window “Command - KEEP”

Field	Explanation
<b>Command</b>	Selected command: <b>KEEP</b>
<b>Source</b>	Enter the source coordinates of the drive or the drive name (e.g. <b>D01</b> ).
<b>Target</b> (optional)	Enter target coordinates only when <ul style="list-style-type: none"> <li>• you do not want to return the medium to its home position</li> <li>• you want to assign a new home position to the medium</li> <li>• you want to perform a drive swap</li> </ul>
<b>Option</b> (optional)	Only for <b>KEEP</b> of media type “Optical Disk”: <b>FL:</b> (Flip) The optical disk is removed from the drive, turned by 180° and then remounted on the drive.

3.7.4 Command “Move...”

Move a medium from one compartment to another (new home position).

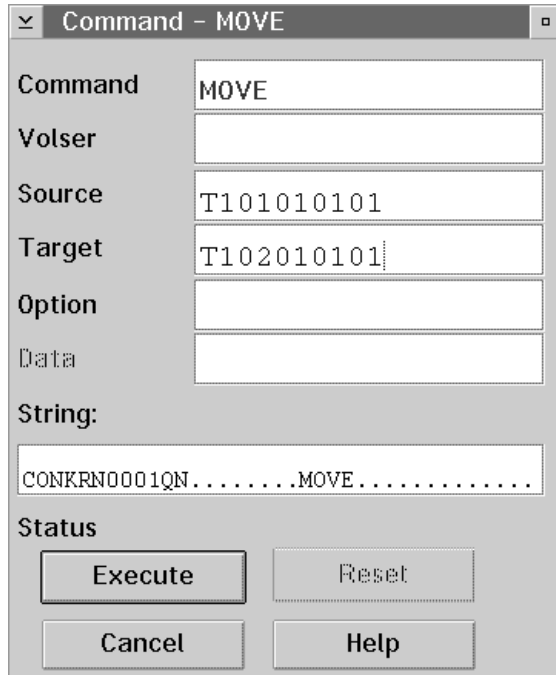

Fig. 3-23: Window “Command - MOVE”

Field	Explanation
<b>Command</b>	Selected command: <b>MOVE</b>
<b>Volser</b>	Enter only the Volser (read barcode and compare with database) or Enter volser and
<b>Source</b>	the source coordinate (read barcode and compare with database and volser in command string) or Enter the only the coordinate (move without barcode check)
<b>Target</b>	the target coordinate of the volser. These will be the new home position of the medium.  (With OD are only coordinates allowed for move without turn OD)
<b>Option</b>	Only for <b>MOVE</b> to the I/O unit <b>JN</b> (Eject Normal): Eject medium but reserve compartment for it. <b>JT</b> (Eject Total): Eject medium and release compartment for a new medium (Volser is set to zero-Volser).

### 3.7.5 Command “Inventory...”

Read the barcode of a compartment or several compartments and check the archive catalog entries for these.

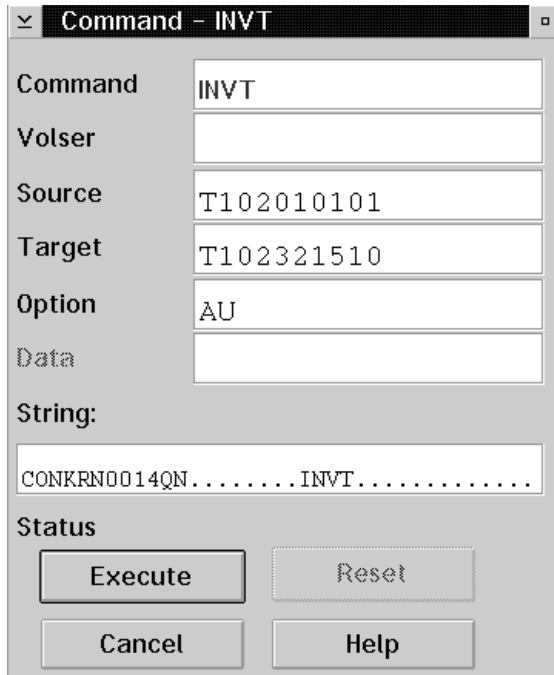

Fig. 3-24: Window “Command - INVT”

Field	Explanation
<b>Command</b>	Selected command: <b>INVT</b>
<b>Volser</b>	Enter the Volser if you want to check only one medium.
<b>Source</b>	Enter <ul style="list-style-type: none"> <li>• the source coordinates if you want to check only one medium or one drive</li> <li>• the start coordinate if you want to check an entire range</li> <li>• a logic input range (e. g. <b>I01</b>)</li> </ul>
<b>Target</b>	Enter the end coordinates if you want to check an entire range.

Field	Explanation
Option	<div data-bbox="612 376 715 479"> </div> <p data-bbox="756 376 956 403"><b>ATTENTION!</b></p> <p data-bbox="756 443 1390 506"><b>When you select option “AI” enter only source coordinates of the type “AMU-Dynamic”.</b></p> <div data-bbox="608 600 719 703"> </div> <p data-bbox="756 600 1390 694"><b>An Optical Disk in the I/O-unit, with reversed side A and B will be not inserted when it has a home positon in the archive.</b></p> <p data-bbox="603 790 1390 853"><b>AI:</b> (Automatic Insert) only for archive coordinates defined in AMU as “AMU-Dynamic” The Volser found (= read by the robot) is inserted when it has a home positon in the archive.</p> <div data-bbox="612 958 715 1061"> </div> <p data-bbox="756 958 956 985"><b>ATTENTION!</b></p> <p data-bbox="756 1025 1422 1151"><b>When you select option “AU” only the AMU archive catalog is altered. Differences between it and the archive catalog in the host may be the consequence!</b></p> <p data-bbox="603 1189 1417 1328"><b>AU:</b> (Automatic Update) only for archive coordinates of the archive The Volser found (= read by the robot) is automatically entered into the archive catalog. (The existing entry is overwritten!)</p> <ul data-bbox="603 1357 1374 1494" style="list-style-type: none"> <li>• Empty compartments with the attributes “Mounted” or “Ejected” are not altered.</li> <li>• Only inconsistencies are protocolled in the LOG Control Center.</li> </ul>

### 3.7.6 Command “Close Unit...”

Close the drive cover of the specified 3X80 drive.

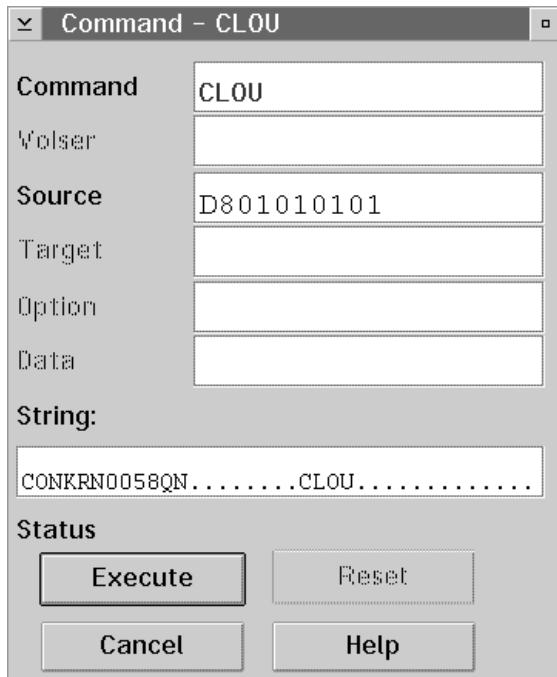

Fig. 3-25: Window “Command - CLOU”

Drives supported:

- IBM 3480/3490 with cover
- Siemens 3590 with cover

Select this command if the robot has not closed the cover of the drive or if the cover has reopened.

Field	Explanation
<b>Command</b>	Selected command: <b>CLOU</b>
<b>Source</b>	Enter the source coordinates of the drive.

### 3.7.7 Command “Unload Unit...”

---

Unload the specified drive.



Command - UNLO

Command UNLO

Volser

Source D901010101

Target

Option

Data

String:

CONKRN0058QN.....UNLO.....

Status

Execute Reset

Cancel Help

Fig. 3-26: Window “Command - UNLO”

Select this command when the 3X90 drive cover has not opened for emergency unload of the drive.

Supported drives:

AML/2 + E

- IBM 3480/3490 with ACL; additional information for the gripper position
- IBM 3480 with cover (AML/2 only)
- OD-512 drive
- OD Reflection drive
- DEC-DLT drive
- OD-Reflection drive
- Siemens 3590 with ACL; additional information for the gripper position
- STK (1) 4480
- STK (2) 4490
- VHS Metrum drive
- Exabyte 8 mm
- DAT 4 mm

AML/J

all drives with unload button



### Information (only for 3X90)

After this command, the robot first grabs for the medium in the “Mount” position during execution of the subsequent “Keep” command, to unload a medium that may not have been drawn in by the drive. If this is not successful it then grabs at the “Keep” position.

Field	Explanation
<b>Command</b>	Selected command: <b>UNLO</b>
<b>Source</b>	Enter the source coordinates of the drive.



### 3.7.8 Command “Status...”

---

Query and set the status of the robot or storage tower, as well as switch-over of the Automatic Data Switch (if provided for).

Command - STAT

Command: STAT

Volser:

Source:

Target:

Option: R1

Data:

String:

CONKRN0014QN.....STAT.....

Status

Execute Reset

Cancel Help

Fig. 3-27: Window “Command - STAT”



#### Information

**The source coordinate is always required for sign-on (ready) of a storage tower.**

Field	Explanation
<b>Command</b>	Selected command: <b>STAT</b>
<b>Source</b>	Enter the source coordinates of the storage tower.

Field	Explanation
<b>Option</b>	Enter the option: <ul style="list-style-type: none"><li>• <b>10</b>: robot 1 ready</li><li>• <b>20</b>: robot 2 ready</li><li>• <b>11</b>: robot 1 not ready</li><li>• <b>21</b>: robot 2 not ready</li><li>• <b>.0</b>: tower ready</li><li>• <b>.1</b>: tower not ready</li><li>• <b>R.</b>: query versions<ul style="list-style-type: none"><li>- Volser: AMU version</li><li>- Source: robot 1 version</li><li>- Target: robot 2 version (display in trace KRN1 only)</li></ul></li><li>• <b>R1</b>: query robot and, if positive confirmation results, set robot 1 ready (ADS switches connection over to control unit)</li><li>• <b>R2</b>: query robot and, if positive confirmation results, set robot 2 ready (ADS switches connection over to control unit)</li></ul>

### 3.7.9 Command “Purge...”

---

Purge a command not yet executed from the AMU command queue.



Fig. 3-28: Window “Command - PRGE”



#### ATTENTION!

Use this command sparingly in exceptional cases!

Field	Explanation
<b>Command</b>	Selected command: <b>PRGE</b>
<b>Data</b>	Select the command to be purged in the pop-up menu and purge the command with <b>Execute</b> : (e. g. <b>CONKRN0332...</b> ) <ul style="list-style-type: none"><li>• sender (<b>CON</b>)</li><li>• requester (<b>KRN</b>)</li><li>• sequence number (<b>0332</b>)</li></ul>

### 3.7.10 Command “Homing...”

Move robot to home position (reference position).



Fig. 3-29: Window “Command - HOME”



#### Information

After moving to the home position the robot reports “not ready”.

Field	Explanation
<b>Command</b>	Selected command: <b>HOME</b>
<b>Option</b>	Enter the robot number (1 or 2).



#### ATTENTION!

Home is a low level command. This command could conflict with other host commands.

- Before executing it stop the host communication or
- perform a Shutdown AML and startup, before restarting production with the system (QVW S. 5-1).

3.7.11 Command “Put...”

**Subcommand: put medium in position.**

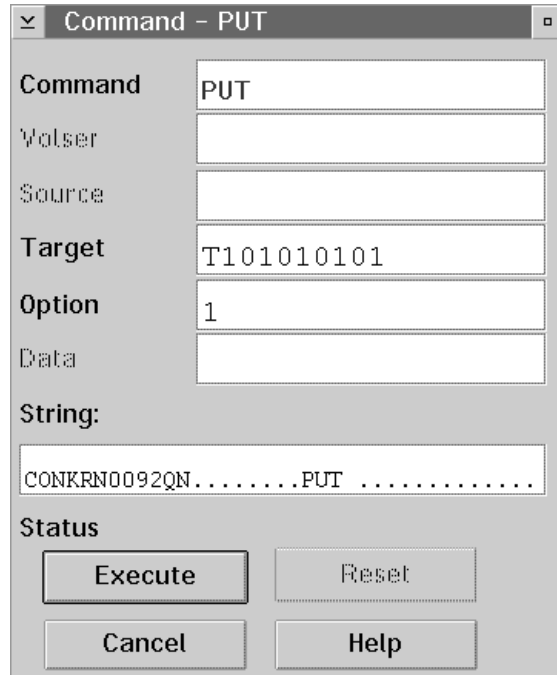

Fig. 3-30: Window “Command - PUT”



**ATTENTION!**

**The archive catalog is not accessed.**

Field	Explanation
<b>Command</b>	Selected command: <b>PUT</b>
<b>Target</b>	Enter the target coordinates.
<b>Option</b>	Enter: <ul style="list-style-type: none"> <li>• 1st digit (required parameter): the robot number ( 1 or 2)</li> <li>• 2nd digit (optional parameter):                             <ul style="list-style-type: none"> <li><b>M</b>: medium type D2 medium</li> <li><b>S</b>: medium type D2 small</li> </ul> </li> </ul>

### 3.7.12 Command “Get...”

Subcommand: get medium from position.

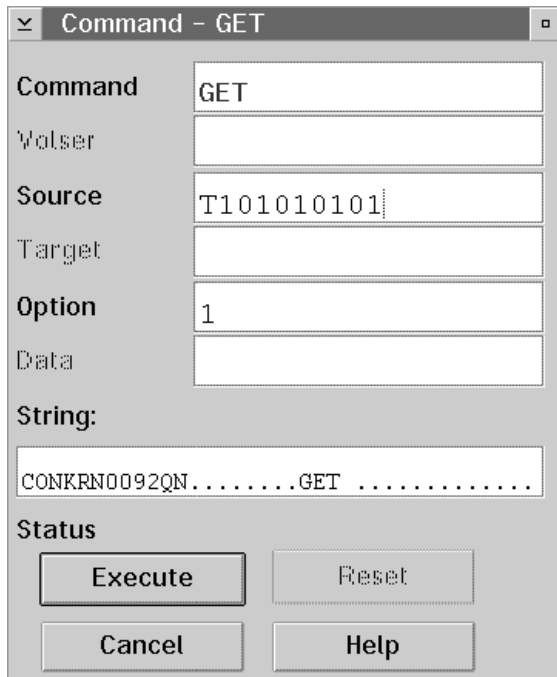

Fig. 3-31: Window “Command - GET”



#### ATTENTION!

The archive catalog is not accessed.

Field	Explanation
<b>Command</b>	Selected command: <b>GET</b>
<b>Source</b>	Enter the source coordinates.
<b>Option</b>	Enter: <ul style="list-style-type: none"> <li>• 1st digit (required parameter): the robot number (<b>1</b> or <b>2</b>)</li> <li>• 2nd digit (optional parameter):                             <ul style="list-style-type: none"> <li><b>M</b>: medium type D2 medium</li> <li><b>S</b>: medium type D2 small</li> </ul> </li> </ul>

**3.7.13 Command “Look...”**

---

Subcommand: read barcode and check attribute.

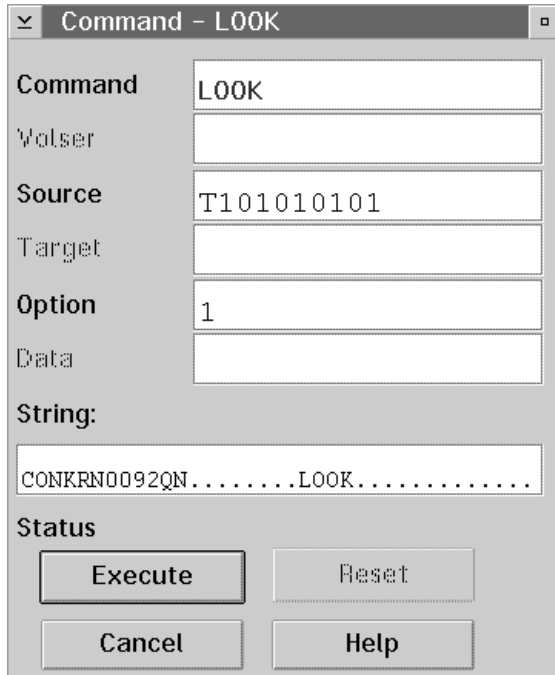

Fig. 3-32: Window “Command - LOOK”



**ATTENTION!**

**The result is not compared to the archive catalog entry.**

Field	Explanation
<b>Command</b>	Selected command: <b>LOOK</b>
<b>Source</b>	Enter the source coordinates.
<b>Option</b>	Enter: <ul style="list-style-type: none"> <li>• 1st digit (required parameter): the robot number (<b>1</b> or <b>2</b>)</li> <li>• 2nd digit (optional parameter):                             <ul style="list-style-type: none"> <li><b>M</b>: medium type D2 medium</li> <li><b>S</b>: medium type D2 small</li> </ul> </li> </ul>

### 3.7.14 Command “Turn...”

Subcommand: turn storage tower to segment.

Fig. 3-33: Window “Command - TURN”



#### ATTENTION!

The result is not compared to the archive catalog entry.

Field	Explanation
<b>Command</b>	Selected command: <b>TURN</b>
<b>Source</b>	Enter the source coordinates.
<b>Option</b>	Enter the robot number (1 or 2).



### 3.7.15 Command “Teach single command”

---



#### ATTENTION!

Transfer the changed teach-point file to the backup or dual-AMU after teaching (only when available) (☞ Page 3-49) and save the file on diskette.

Select this command from the menu **Service - Teach**.

Teach a single object, e. g. a tower segment or a drive.

Command - TEAC

Command: TEAC

Wolser:

Source: T101010101

Target:

Option: 1N

Data:

String:  
CONKRN0092QN.....TEAC.....

Status

Execute Reset

Cancel Help

Fig. 3-34: Window “Command - TEAC”



#### Information

This is the more complicated way of teaching. For initial teaching of the entire system it is too cumbersome.

Use this command when teaching individual components.

Field	Explanation
<b>Command</b>	Selected command: <b>TEAC</b>
<b>Source</b>	Enter the source coordinates.

Field	Explanation
<b>Option</b>	<p>Enter the parameter for precise specification:</p> <ul style="list-style-type: none"><li>• on AML/J only <b>1, 1N</b></li><li>• on AML/E only <b>1, 1N</b></li><li>• on AML/2 for robot 1 <b>1, 1N</b> for robot 2 on twin systems also <b>2, 2N</b></li></ul> <p><b>1N</b> or <b>2N</b>: new teach (All data of the component in KRNREFPT.R01 or KRNREFPT.R02 or KRNREFPT.R00 are deleted. The target coordinates are retrieved from the configuration. The entire component must be retaught.)</p> <p><b>1 or 2</b> : re-teach Correction of the coordinates (the data from KRNREFPT.R01 or KRNREFPT.R02 or KRNREFPT.R00 are corrected).</p>

### 3.7.16 Command “Teach MTCGDialog”



#### ATTENTION!

Transfer the changed teach-point file to the backup or dual-AMU after teaching (only when available) (☞ Page 3-49) and save the file on diskette.

Select this command from the menu **Service - Teach**.

Graphically supported teaching, e. g. of a Quadro tower, several drives or the entire system.

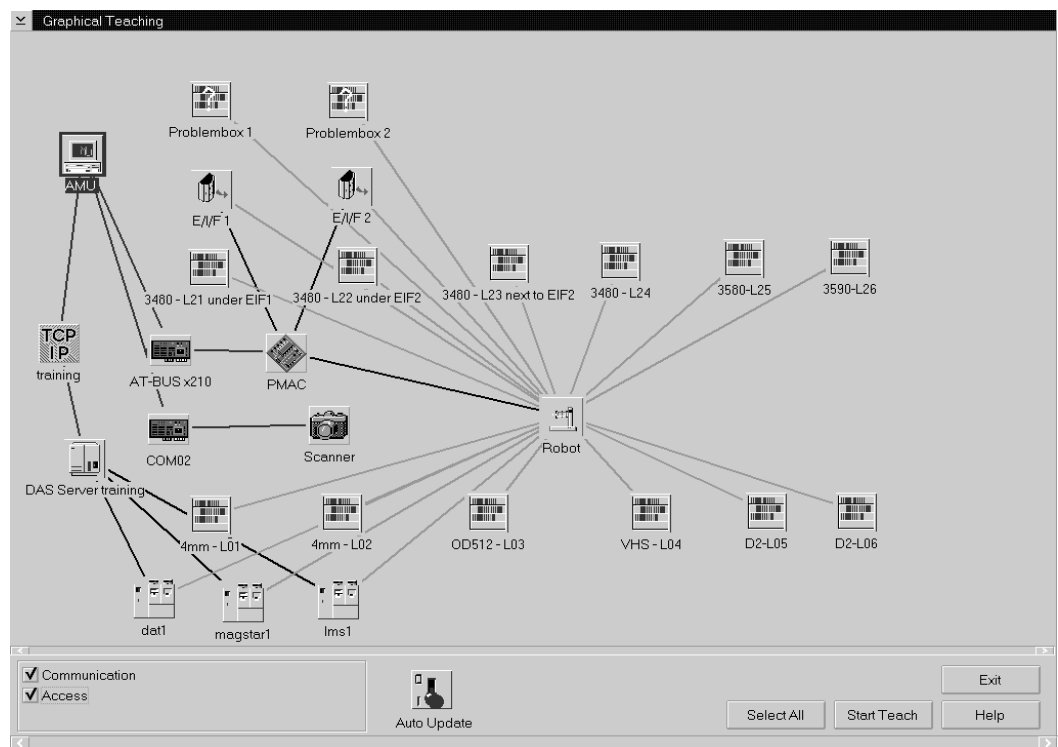



Fig. 3-35: Window “Graphical Teaching”

Command	Explanation
<b>Connection</b>	Switch allowing to display or hide the connections <ul style="list-style-type: none"> <li>• <b>Communication</b>: data connection</li> <li>• <b>Access</b>: mechanic access</li> </ul>
<b>Auto Update</b>	Here no function.
<b>Select All</b>	Select all components.
<b>Unselect All</b>	Unselect all components.

Command	Explanation
	<p>Selecting a single component:</p> <ul style="list-style-type: none"> <li>• teach (1): click once with the left mouse button - the component is shown in red</li> <li>• re-teach (1N): click twice with the left mouse button - the component is shown in dark blue</li> </ul> <p>To select several components keep &lt;CTRL&gt; pressed.</p>
	<div style="display: flex; align-items: flex-start;"> <div style="margin-right: 20px;">  </div> <div> <p><b>Information</b></p> <p><b>To determine which robot teaches the component you must select the robot, the component and the connection.</b></p> <p><b>When you teach a drive the system prompts you to check if the teach rule has been inserted.</b></p> <p><b>How to proceed with a twin robot:</b></p> <ul style="list-style-type: none"> <li>• <b>robot 1 begins with the first tower in ascending order</b></li> <li>• <b>robot 2 begins with the last tower in descending order</b></li> </ul> </div> </div>
	<p>After teaching:</p> <ul style="list-style-type: none"> <li>• component appears green: no errors</li> <li>• component appears dark brown: error message and prompt <ul style="list-style-type: none"> <li>- <b>Retry</b>: teach once more</li> <li>- <b>Ignore</b>: ignore error and teach the next component</li> <li>- <b>Abort</b>: abort the teaching (all components)</li> </ul> </li> </ul>
<b>Start Teach</b>	Start the teach routine for the selected components.
<b>Stop Teach</b> (during teaching only)	Stop the teach routine.

### 3.8 Menu Service

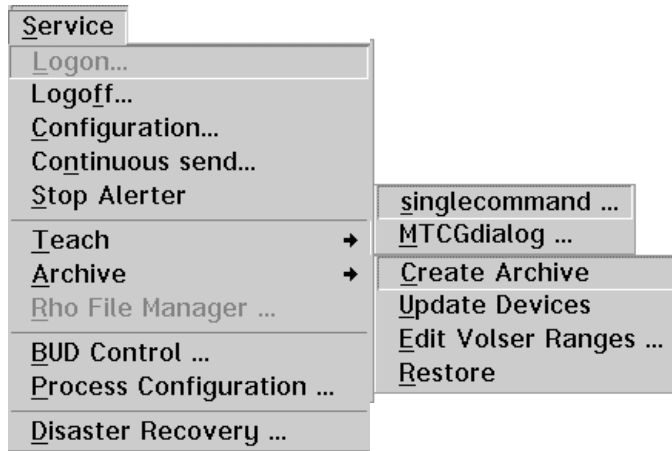

Fig. 3-36: Menu "Service"

All commands in this menu (except **Logon ...**) are provided exclusively for service personnel and are protected by a password.

Command	Field	Explanation
Logon...	Logon of service personnel with password.	

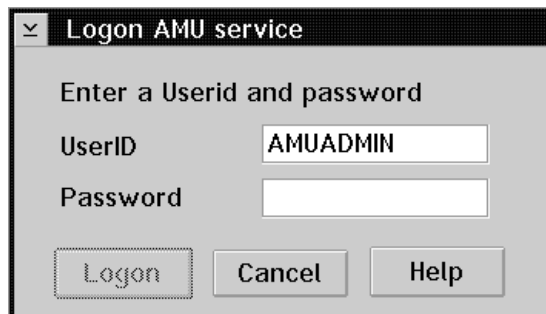

Fig. 3-37: Window "Logon AMU service"



**Information**

The logon is registered with the user ID in the log file and remains valid until either of the commands "Logoff" or "Shutdown AML" are used.

**Do not forget to log off.  
Unauthorized personnel could make alterations!**

Command	Field	Explanation
Logoff...		Logoff of service personnel.

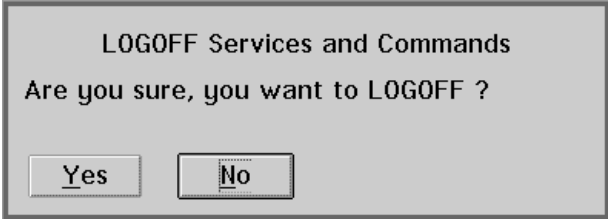

Fig. 3-38: Window Logoff AMU service

Configura- tion...	Configure the AML system.
-----------------------	---------------------------

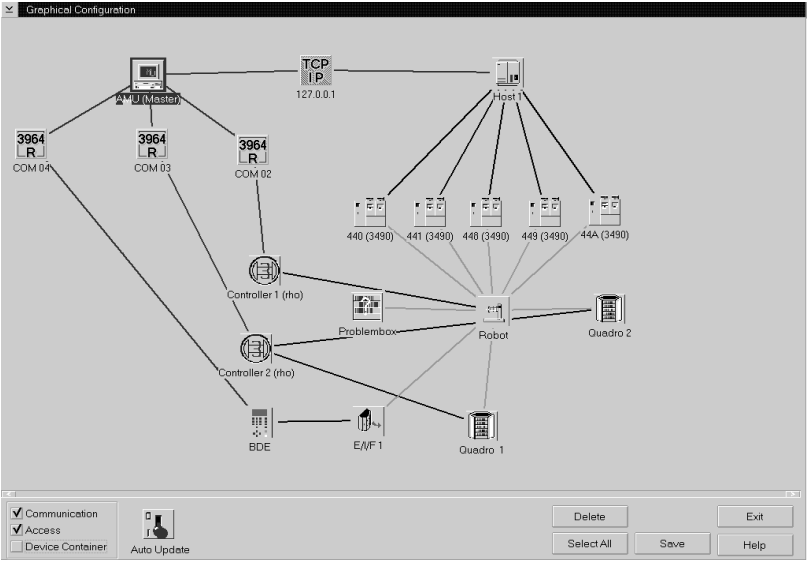

Fig. 3-39: Window "Graphical Configuration"

(👉 Page 3-57)

Command	Field	Explanation
<b>Continuous send...</b>		System test tool used without host: execute a single command or several commands in sequence. The commands are stored in the file "CONCONT.INI".



**Information**

The file CONCONT.INI from version 2.0 must not be used in version 2.2 or higher (wrong format results in an AMU software crash).

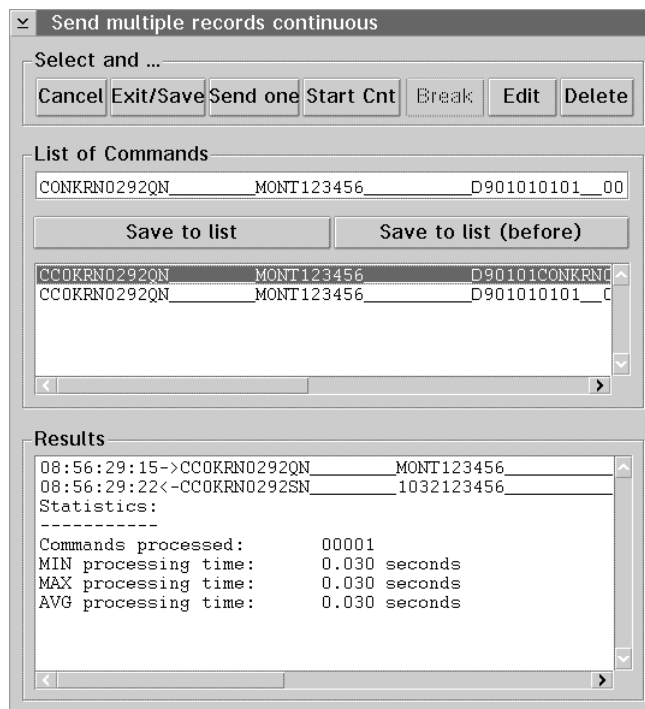

Fig. 3-40: Window "Send multiple records continuous"



<b>Exit/Save</b>	Exit and save "Continuous send".
<b>Send one</b>	Execute the selected commands once (command sequence).
<b>Start Cnt</b>	Execute the selected commands continuously in a loop. The item changes to <b>Stop Cnt</b> as the commands are executed.
<b>Stop Cnt</b>	Displayed only while a loop is being executed. Stop the "Continuous send" after execution of the last command in the loop.
<b>Break</b>	Break the "Continuous send" after execution of the current command.

<b>Command</b>	<b>Field</b>	<b>Explanation</b>
<b>Continuous send...</b> (continued)	<b>Edit</b>	Edit the selected command.
	<b>Delete</b>	Delete all selected commands.
	<b>Save to list</b>	Add the command edited with <b>Edit</b> at the end of the list.
	<b>Save to list (before)</b>	Add the command edited with <b>Edit</b> before the selected command.

Procedure illustrated with a “**Move**” command.

- a) Select **Continuous send...** (menu **Service**)
- b) Select **Move...** (menu **Commands**)
- c) Enter the parameters
  - Volser
  - source coordinates
  - target coordinates
- d) Copy the command string (from the command window)
  - select the command string (put the cursor at the beginning of the string and mark the entire string keeping the left mouse button pressed)
  - select **Copy** (menu **Edit**)
- e) Put the command string into the window Continuous send
  - put the cursor on “**List of Commands**”
  - select **Paste** (menu **Edit**)
- f) Select the command **Save to list** or **Save to list before**
- g) Select all commands to be executed
- h) Select **Start Cnt** or **Send one**.  
All selected commands are executed



Command	Field	Explanation
<b>Stop Alerter</b>		<p>The alerter (program ART.EXE) writes logs and traces. Terminate the alerter if you want to copy an active log file to disk:</p> <ol style="list-style-type: none"> <li>stop the host communication (e. g. hold on HACC)</li> <li>select <b>Stop Alerter</b></li> <li>copy the log file</li> <li>restart the alerter (open the LOG Control Center)</li> </ol>
		<p> <b>ATTENTION!</b></p> <p><b>When the alerter has been stopped no logs and traces are written! Restart the alerter as soon as possible.</b></p>
<b>Teach... ...single command</b>		Teach a single object, e. g. a tower segment or drive. The command opens the command window (☞ Page 3-39).
<b>Teach... ...MTCG dialog</b>		Graphically supported teaching, e. g. of a Quadro tower, several drives or the entire system. The command opens the window “Graphical Teaching” (☞ Page 3-41).
<b>Archiv...</b>	<b>Create Archive</b>	<p> <b>ATTENTION!</b></p> <p><b>This command creates a new archive catalog. The existing archive catalog of the AML system is irreversibly deleted!</b></p> <p>The new archive catalog is created on the basis of the configuration data.</p>
	<b>Update Devices</b>	<p>Function for adaption of the archive catalog to the graphical configuration.</p> <p>It must be used when the kind and number of components has been changed.</p>

Command	Field	Explanation
	<b>Edit Volser Ranges</b>	Function for reassignment of compartments. The archive catalog is internally restructured and not created afresh (QVW S. 4-27)..
		

Fig. 3-41: Window "Edit Volser Ranges"

**Archiv...**  
(continued)

**Restore**

Restore the archive catalog when the data-base backup system is switched on (☞ Page 3-51).

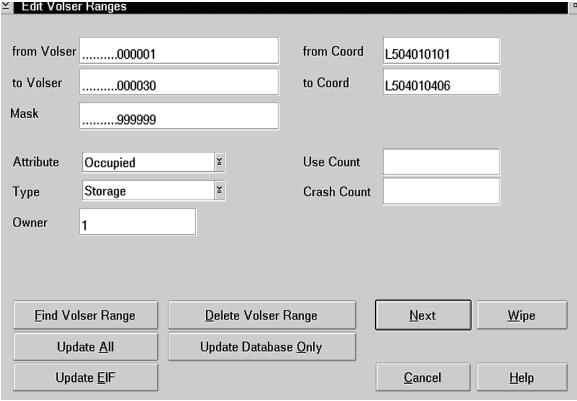

**Information**

The database backup system saves the entire archive catalog daily at the time entered in Process Configuration and protocols all changes thereafter.

Changes effected with Edit Volser Range or SQL commands are not recorded in the journal file.

**Rho File Manager**

The Rho File Manager transfers data between AMU and rho control in both directions (☞ Page 4-1).



**ATTENTION!**

Stop the communication of host and AMU before calling up the Rho File Manager.

After a safety query the robot moves to its initial position and the AMU function stops (kernel is terminated).

Command	Field	Explanation
<b>BUD Control...</b>		Transfer configuration files and database to the dual-AMU.

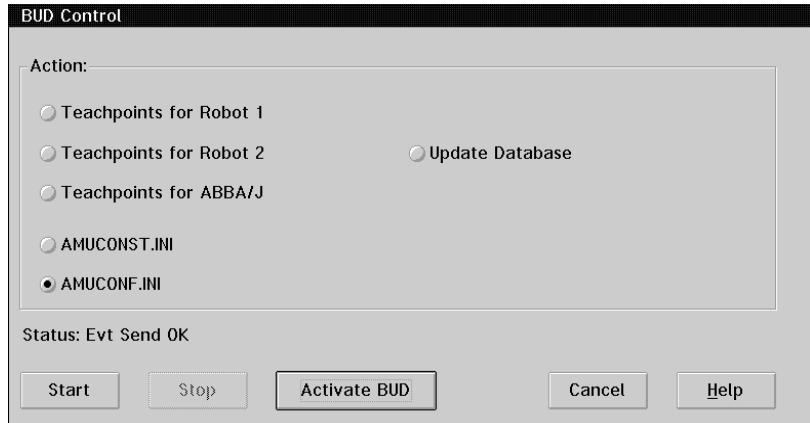



Fig. 3-42: Window "BUD Control"

**Teachpoints for Robot 1**

Transfer KRNREFPT.R01 for robot 1 to the dual-AMU (required after teaching with robot 1). The existing teach-point file is automatically saved (KRNREFPT.R10). All previous backups are renamed (R10 -> R11) and the oldest file (R19) is erased.

**Teachpoints for Robot 2**

Transfer KRNREFPT.R02 for robot 2 to the dual-AMU (required after teaching with robot 2). The existing teach-point file is automatically saved (KRNREFPT.R20). All previous backups are renamed (R20 -> R21) and the oldest file (R29) is erased.

Command	Field	Explanation
<b>BUD Control...</b> (continued)	<b>Teachpoints for AML/J</b>	Transfer KRNREFPT.R00 for AML/J to the dual-AMU (required after teaching with AML/J). The existing teach-point file is automatically saved (KRNREFPT.R01). All previous backups are renamed (R01 -> R02) and the oldest file (R09) is erased.
	<b>Update Database</b>	Update the database in the Dual-AMU (the entire database is transferred).
		 <p><b>Information</b></p> <p><b>With an RS232 connection the transfer may take several hours.</b></p>
	<b>AMU-CONST.INI</b>	Transfer the configuration file AMUCONST.INI to the dual AMU. The existing file is automatically saved (AMUCONST.B01). All previous backups are renamed (B01 -> B02) and the oldest file (B09) is erased.
	<b>AMUCONF.INI</b>	Transfer the configuration file AMUCONF.INI to the dual-AMU. The existing file is automatically saved (AMUCONF.B01). All previous backups are renamed (B01 -> B02) and the oldest file (B09) is erased.
	<b>Activate BUD</b>	Activate BUD on this computer (AMU turned into master AMU)
		 <p><b>ATTENTION!</b></p> <p><b>If the host connection is active, switch over from the host with the command ROSA. When Activate BUD is selected the host will not be informed of the changed situation.</b></p>
	<b>Start</b>	Start the selected adjustment.
	<b>Stop</b>	Stop the selected adjustment.

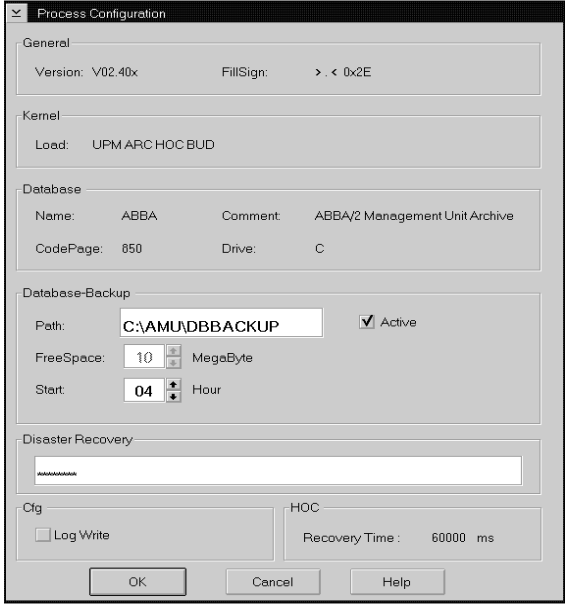
Command	Field	Explanation
Process Configuration		Overview of the system adjustments within the AMU software and adjustment of parameters for the database backup.
		

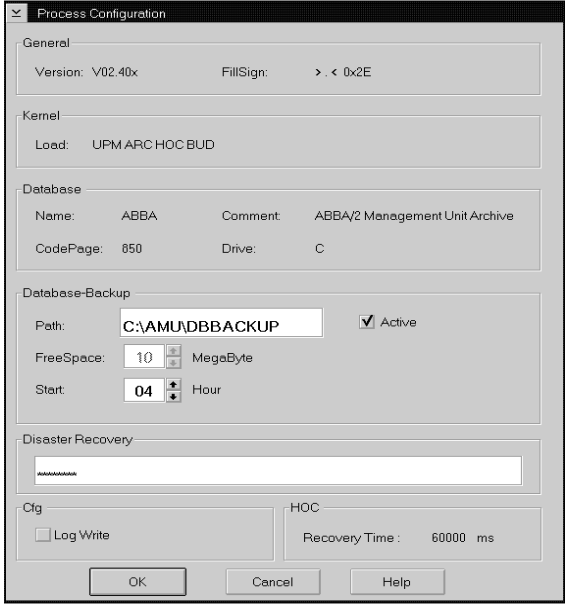

Fig. 3-43: Window "Process Configuration"

<b>General</b>	<p><b>Version:</b> Display current software release (parameter PROC VERSION in the file "AMUCONF.INI").</p> <p><b>FillSign:</b> Display which sign is used to fill up the variables in the command string (e. g. &lt;.&gt;).</p>
<b>Kernel</b>	<p>Display all processes that are started after the kernel (parameter PROC KRNLOAD in the file "AMUCONF.INI").</p> <ul style="list-style-type: none"> <li>• <b>UPM:</b> User Profile Manager</li> <li>• <b>ARC:</b> Archive Handler</li> <li>• <b>HOC:</b> Host and other communication</li> <li>• <b>BUD:</b> Backup Daemon</li> </ul>
<b>Database</b>	<ul style="list-style-type: none"> <li>• <b>Name:</b> Name of SQL database (e. g. <b>AML</b>)</li> <li>• <b>Comment:</b> comment</li> <li>• <b>CodePage:</b> Indicates the codepage of the SQL database (e. g. <b>850</b>)</li> <li>• <b>Drive:</b> Drive the SQL database is stored on (e. g. <b>C</b>)</li> </ul>

Command	Field	Explanation
Process Configuration (continued)	Database Backup	<ul style="list-style-type: none"> <li>• <b>Path:</b> Directory and drive storing the backup and journal files. C:\AMU\DBBACKUP is the standard directory. To be able to access the backup after hardware damages of the AMU computer (e. g. disk crash) an additional harddisk can be installed and used for backup via a LAN network (parameter PROC DBBACKUPPATH in the file "AMUCONF.INI").</li> </ul>



**ATTENTION!**

**Activated only after restart of AMU!**

- **Active:** Switch the backup system on or off (parameter PROC DBBACKUPACTIVE in the file "AMUCONF.INI").
- **FreeSpace:** Information on the storage management of the backup system. If the free disk space available in the directory, defined with **Path**, drops below the defined value, the following are deleted:
  - the oldest backup and journal files (until the value for **FreeSpace** is reached)
  - any backup older than five days



**Information**

**If the same drive is used for AMU and DBBACKUP the value of 10 MB cannot be altered!**

- **Start:** Start time for backup (parameter PROC DBBACKUPSTARTEHOUR in the file "AMUCONF.INI").

Command	Field	Explanation
<b>Process Configuration</b> (continued)	<b>Disaster Recovery</b>	Password for call-up of the disaster recovery procedure (display is coded). When erase the entry on this field you can call up the <b>Disaster Recovery</b> function without entering a password.
	<b>Cfg</b>	<b>Log Write:</b> Select whether to write each configuration activity to the log file or not (parameter PROC CFGLOG in the file "AMUCONF.INI").
	<b>HOC</b>	<b>Recovery Time:</b> Time interval after which the communication module checks all configured communication connections; parameter PROC HOCRECOVERYTIME in the file "AMUCONF.INI")

Command	Field	Explanation
<b>Disaster Recovery</b>	Dialog window starting ejection of selected media in case of emergency (disaster recovery)	
		
	<b>Robot 1 / Robot 2</b>	Subdivision in two areas for independent eject with robot 1 and robot 2 on AML/2 twin robot systems
	<b>File</b>	Window for selection of prepared files listing Volsers to be ejected  Display all files in the directory C:\AMU\RECOVERY\ with the filename * .DSR
	<b>Start</b>	Start the ejection of media listed in the selected file.
	<b>Stop</b>	Stop ejection
	<b>Status</b>	Display the current eject status

Fig. 3-44: Window "Disaster Recovery"



### 3.9 Menu Window

---

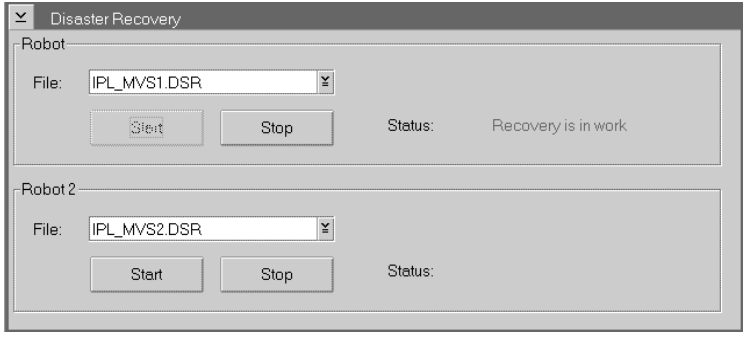
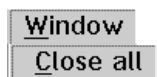

Fig. 3-45: Menu "Window"

Command	Explanation
<b>Close all</b>	Close all open windows.
<b>Window</b> (List of all open windows)	Call up the respective window.

### 3.10 Menu Help

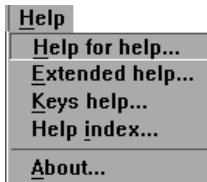

Fig. 3-46: Menu "Help"

Command	Explanation
<b>Help for help...</b>	Information about the help function.
<b>Extended help...</b>	<p data-bbox="564 806 759 835">Extended Help</p> 
<b>Help index...</b>	Help index
<b>About...</b>	Display copyright information and AMU version number.

Fig. 3-47: Window "Help for AMU - (AML Management Unit)"

### 3.11 Configuration

---

This menu is used to configurate the entire AML system.

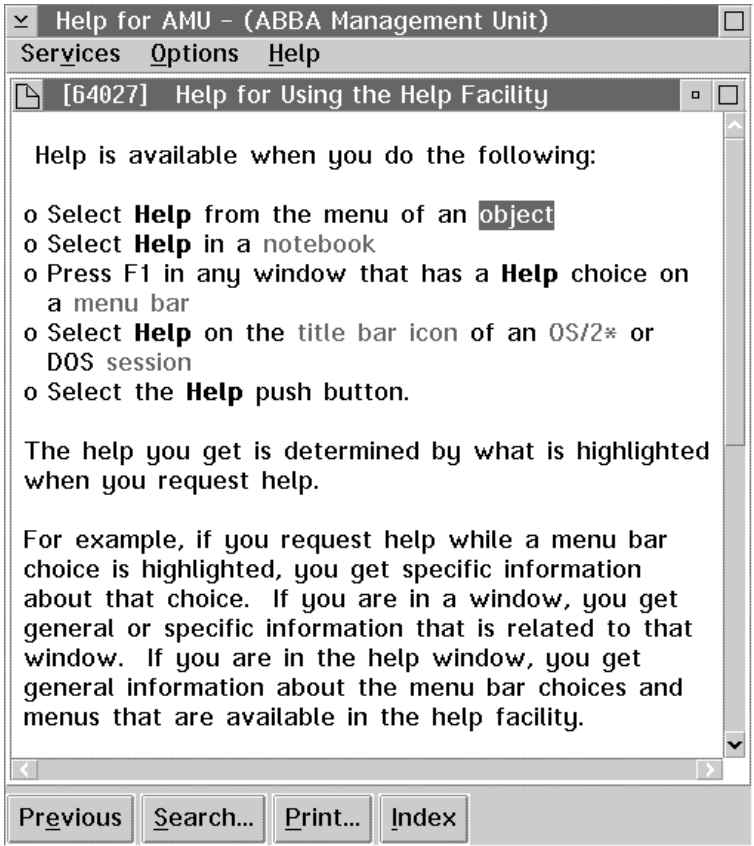
#### 3.11.1 Window Graphical Configuration

---

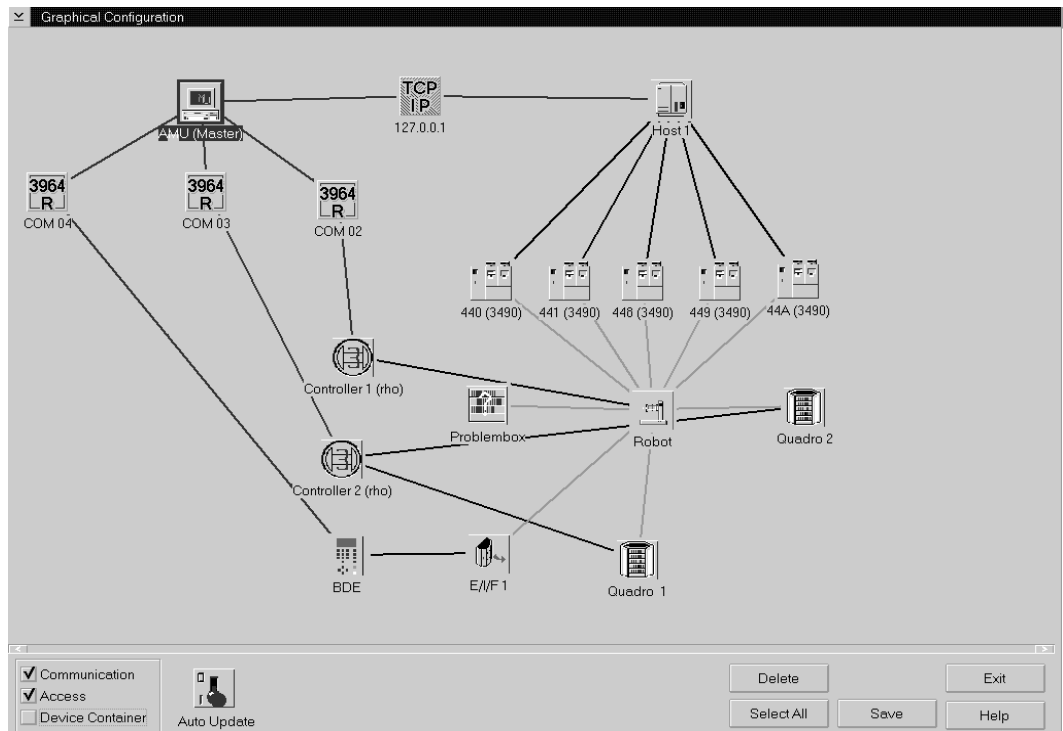

Fig. 3-48: Window "Graphical Configuration" (Example AML/2)

Field	Explanation
<b>Device Container</b>	Switch allowing to show/hide the window <b>Device Container</b> .

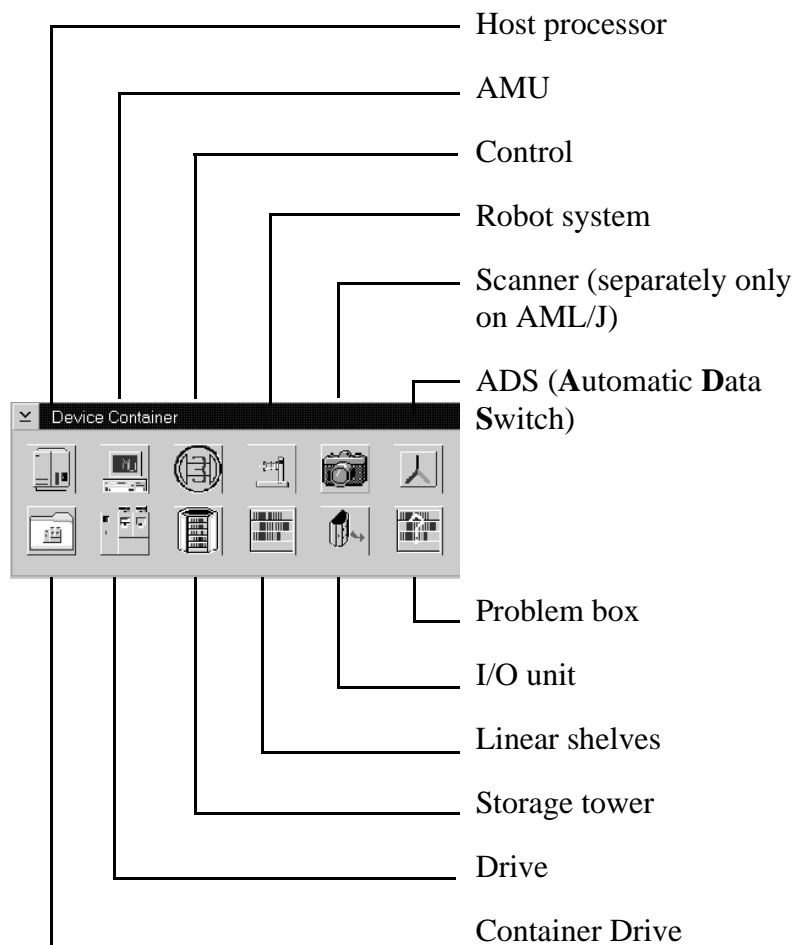



Fig. 3-49: Window "Device Container"

<b>Communication</b>	Switch allowing to show/hide the connections. <b>Communication</b> (black): hardware connection
<b>Access</b>	Switch allowing to show/hide the connections. <b>Access</b> (green): responsible = logic connection
<b>Drive-Count in Hex</b>	Switch for count mode of drive names (hexadecimal or decimal). Select hexadecimal if more than 100 drives are involved (on HACC/MVS HACCPARM parameter UNITNUM=HEX)

## Configuration

---

Field	Explanation
<b>Auto Update</b>	Automatic update of display contents after each change.
	<p><b>Information</b></p> <p> <b>To switch over click on the switch with the right mouse button.</b></p>
<b>Save</b>	Save the configuration in AMUCONF.INI and save the old file to CONFAMU.INI.
	<p><b>Information</b></p> <p> <b>After saving the configuration file transfer it to the backup or dual-AMU (only if available) (☞ Page 3-49) and save the file on a diskette.</b></p>
<b>Delete</b>	Delete the selected (marked in red) component from the layout.
<b>Select All</b>	Select all elements (icons).
<b>Exit</b>	Exit the graphic configuration without saving.

3.11.2 The Configuration Procedure

**Configuring a component**

- a) Pull the desired component into the configuration window with pressed right mouse button.  
Position the icon in the configuraton window by clicking with the right mouse button and moving the mouse.
- b) Open the configuration window with a double click on the item.



**Information**

**Only one configuration window at a time can be opened.**

**Deleting a component**

- a) Mark the icon to be deleted or the connecting line by clicking on it (the symbol is marked in red).  
Mark several symbols by keeping the <CTRL> key pressed while clicking.
- b) To delete all selected symbols click on **Delete**.

**Defining connections**

- a) Click on the first icon with the left mouse button, keep the mouse button pressed and pull the mouse to the second symbol.  
On AMU communication connections an icon is shown on the connecting line (communication parameters).

Required connections

From	To
HOST	AMU
	drive

From	To
AMU	controls
	ADS
	scanner (AML/J)

## Configuration

---

From	To
control	robot
	storage tower
	I/O unit

From	To
robot	drive
	storage tower
	linear shelf
	I/O unit
	problem box

### Saving the configuration

b) After configuring click on **Save**.

### 3.11.3 Configuration Windows of AMU Communication

#### Interface Configuration



#### Information

The communication adjustments in the AMU software must agree with the adjustments in the communication software of AMU and host.

On the black connecting lines to AMU you can see communication icons.

- a) Open the icon with a double click.  
The window **Interface Configuration** open.
- b) In the field **Type** select the type of communication.

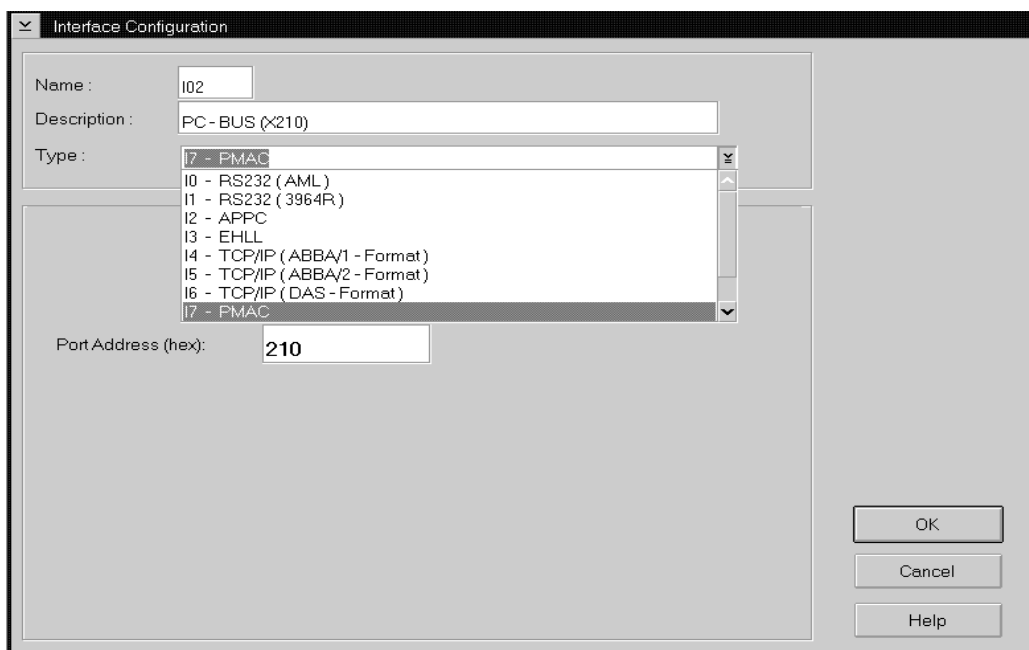

Fig. 3-50: Window "Interface Configuration" (Example AT-Bus Communication AML/J)



## Configuration

### Types

Type	Description	Hardware	Standard Applications
I0	RS 232 (AML)	RS 232C	ROBAR, HACC Guardian, dual-AMU
I1	RS232 (3964R)	RS 232C	robot control rho, I/O unit/A
I2	APPC (LU6.2)	Token Ring; ISDN	HACC/MVS, HACC/OS400
		SDLC	HACC/MVS
I3	EHL (LU2)	Token Ring- KOAX	HACC/MVS
	EXCP (3270)	KOAX	HACC/MVS, HACC/VM
I4	TCP/IP (ABBA/1 format)	Ethernet, Token Ring, ISDN	ROBAR (as of version 2.6)
I5	TCP/IP (AML/2 format)		AMASS, VolServ, dual-AMU
I6	TCP/IP (DAS format)		DAS Unix and DAS/2 until version 1.2mb * (DAS/2 1.3 communication with events without any ent- rance in graphical configura- tion)
I7	PMAC	AT bus	PMAC board
I8	RS232 Scanner	RS 232C	AML/J barcode scanner
I9	RS 232 Sotec Multiport	Sotec multiport board	robot controls, I/O unit/A dual-AMU ROBAR HACC/Guardian

\* DAS/2 1.3 are without any entrance in graphical configuration

**RS232 Interface  
(I0 - RS232 (AML)Protocol + I1 - RS232 (3964 R)Protocol)**

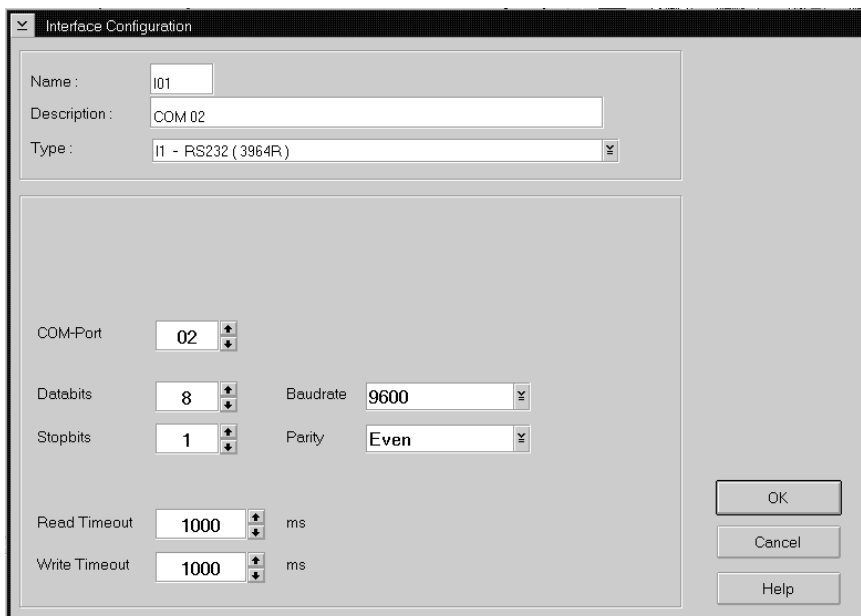

Fig. 3-51: Example RS232 Interface

Field	Explanation	
Interface Type	AML	Siemens 3964R
	<ul style="list-style-type: none"> <li>• AMU - Host computer</li> <li>• AMU - AMU</li> </ul>	<ul style="list-style-type: none"> <li>• AMU - rho</li> <li>• AMU - I/O unit/A</li> </ul>
Name	Automatically generated name of internal connection (I01, I02 ...).	
Description	Free comment (e.g. name of the interface "COM 02")	
COM-Port	Hardware interface; COM port (e. g. 02)	
Databits	Length of data byte: 8 Bit	
Stopbits	2 stop bits	1 stop bit
Parity	None (no parity bit)	Even (even parity bit)
Baudrate	Baudrate: 09600	
Read Timeout	2000 ms	do not change
Write Timeout	1000 ms	do not change

I2 APPC (LU6.2)

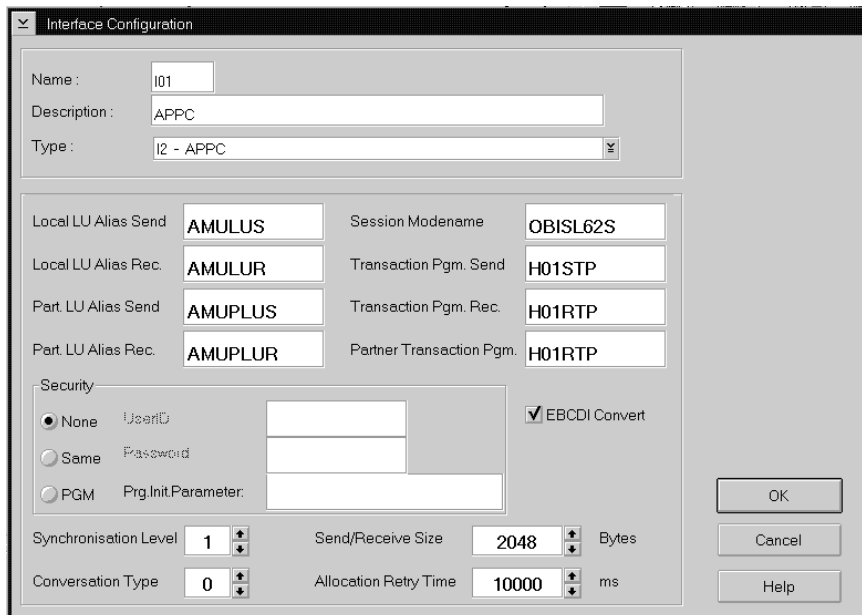



Fig. 3-52: Example APPC Interface

Field	Explanation
Name	Automatically generated name of internal connection (I01, I02 ...).
Description	Free comment
<b>Information</b>	
	The adjustment of the following parameters “Alias names” in the AMU software must agree with the adjustments in the Communications Manager.

Field	Explanation
<b>Local LU Alias Send</b>	<p>Alias (reference name) for the local Logical Unit (LU of AMU) for sending. Defaults:</p> <ul style="list-style-type: none"> <li>• Single Session: AMULUS</li> <li>• Parallel Session: AMULU</li> </ul>
<b>Local LU Alias Rec.</b>	<p>Alias (reference name ) for the local Logical Unit (LU of AMU) for receiving. Defaults:</p> <ul style="list-style-type: none"> <li>• Single Session: AMULUR</li> <li>• Parallel Session: AMULU</li> </ul>
<b>Part. LU Alias Send</b>	<p>Alias (reference name ) for the partner Logical Unit (LU of HOSTs or partner AMU) for sending. Defaults:</p> <ul style="list-style-type: none"> <li>• Single Session: AMUPLUS</li> <li>• Parallel Session: AMUPLU</li> </ul>
<b>Part. LU Alias Rec.</b>	<p>Alias (reference name ) for the partner Logical Unit (LU of HOSTs or partner AMU) for receiving. Defaults:</p> <ul style="list-style-type: none"> <li>• Single Session: AMUPLUR</li> <li>• Parallel Session: AMUPLU</li> </ul>

Field	Explanation
<b>Session Modename</b>	Logmode in host software VTAM and HACC (description of the session characteristics)
	<b>Information</b>
	<p>Configure the modename to be the same as in the Communications Manager. Be sure to observe correct upper case/lower case spelling.</p> <p>Defaults:</p> <ul style="list-style-type: none"> <li>• Single Session: OBISL62S</li> <li>• Parallel Session: OBISL62P</li> </ul>
<b>Transaction Pgm. Send</b>	<p>Define verbs and parameters at the protocol interface to LU 6.2 for sending (☞ IBM documentation APPN)</p> <p>Default: H01STP</p>
<b>Transaction Pgm. Recu.</b>	<p>Define verbs and parameters at the protocol interface to LU 6.2 for receiving (☞ IBM documentation APPN)</p> <p>Default: H01RTP</p>
<b>Partner Transaction Pgm.</b>	<p>Define verbs and parameters at the protocol interface to LU 6.2 of partner LU (☞ IBM documentation APPN)</p> <p>Default: H01RTP</p>

Field	Explanation
Security	<p style="text-align: center;"><b>Information</b></p> <div style="display: flex; align-items: center;">  <p><b>This parameter is used only on HACC/OS400.</b></p> </div>
None	<b>Security</b> parameters are not used.
Same	During setup of the conversation (connection between two transaction programs TPs) user-Id and password are checked.
PGM	Parameters for transaction program are transferred from the Attach Manager to the transaction program.
UserID	Name of the user authorized to start the conversation.
Password	Password of the user authorized to start the conversation.
Prg Init. Parameter	Start parameters for dir transaction programs, which are transferred from the Attach Manager to the transaction program of the partner.
EBCDI Convert	Convert data from ASCII into EBCDI format and back. Must be switched off for AMU <=> AMU connection via APPC.
<b>Send/Receive Size</b>	Size of the internal buffer for sending and receiving Default: 2048 bytes
<b>Conversation Type</b>	Type of conversation (☞ IBM documentation APPN) 0: Basic Conversation - for HACC/MVS 1: Mapped Conversation - for HACC/OS/400
<b>Synchronisation Level</b>	Conversation with confirmation (☞ IBM documentation APPN) 0: none 1: confirm (default)
<b>Allocation Retry Time</b>	Interval for new "ALLOCATE" trial (setup of connection)  Default: 10000 ms

**I3 EHLL (LU 2,EXCP)**

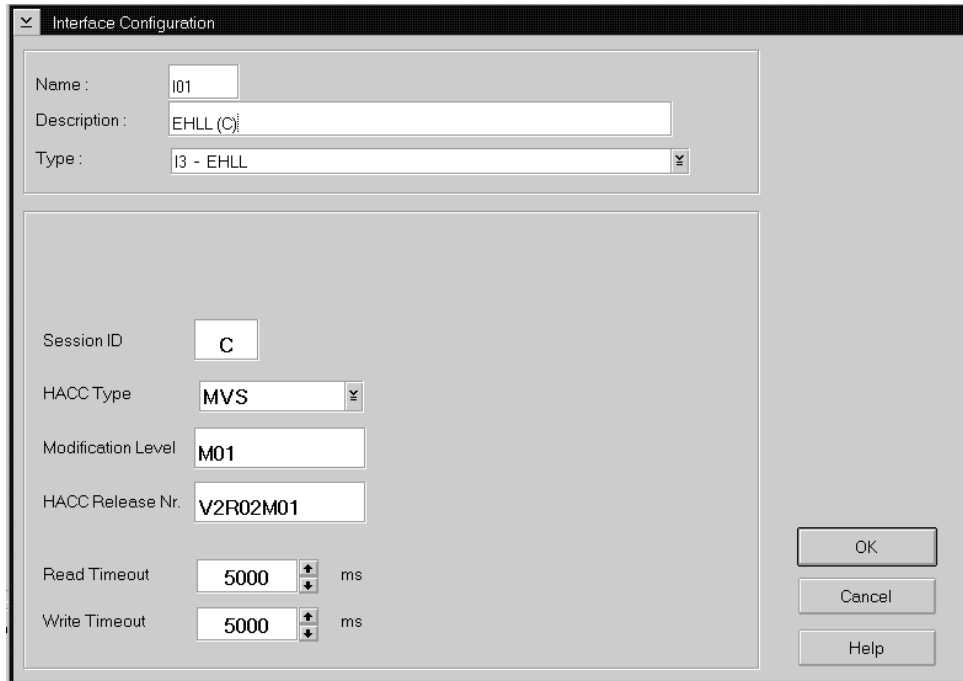

Fig. 3-53: Example EHLL Interface

Field	Explanation
<b>Name</b>	Automatically generated name of internal connection (I01, I02 ...).
<b>Description</b>	Free comment
<b>Session ID</b>	Same name as in the Communication Manager (CM), default C (A, B, C, D, E are possible).
<b>HACC Typ</b>	VM or MVS (parameter adjusting the timing characteristics of the communication)
<b>Modification Level</b>	M00 echo line in presentation space not expected M01 echo line in presentation space expected
<b>HACC Release Nr.</b>	HACC release (input is compared with the version statement in the presentation space but not processed further. Errors are not processed.)
<b>Timeout Read</b>	05000 ms
<b>Timeout Write</b>	05000 ms

TCP/IP connections

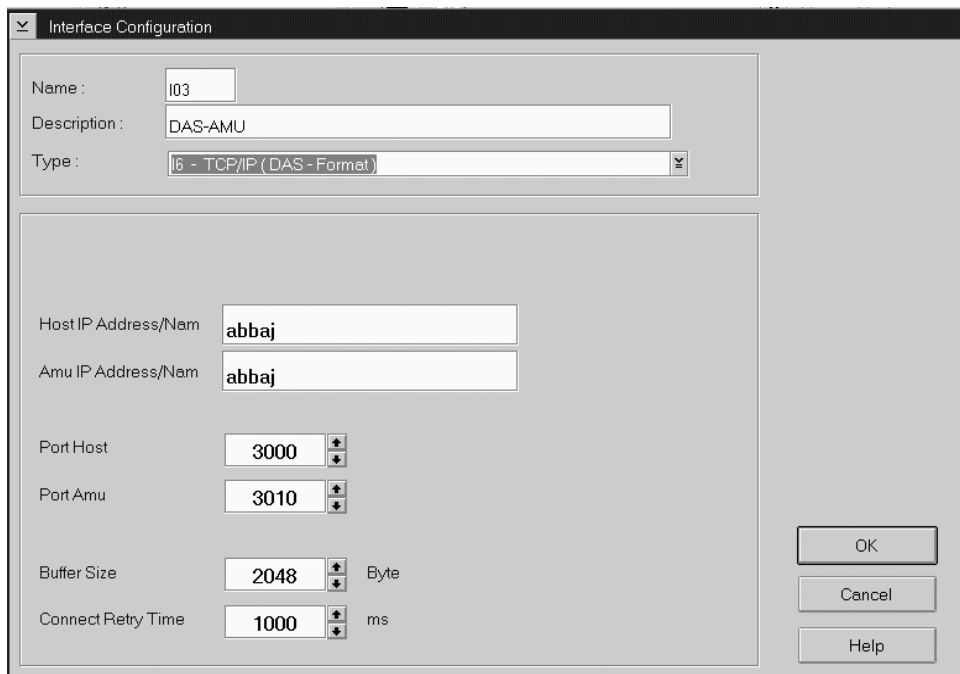

Fig. 3-54: Example TCP/IP Interface

Field	Explanation
<b>Name</b>	Automatically generated name of internal connection (I01, I02 ...).
<b>Description</b>	Free comment
<b>Type</b>	<p><b>I4-TCP/IP (ABBA/1-Format)</b>                      Command protocol "ABBA/1" (66 or 80 bytes string length) for communication with host software e.g. HACC/MVS and HACC/VM via Ethernet.</p> <p><b>I5-TCP/IP (AML/2-Format)</b>                      Command protocol "AML/2" (variable string length with fixed protocol head length and variable data field) for communication with host software.</p> <p><b>I6-TCP/IP (DAS-Format)</b>                      Command protocol "AML/2" but with additional acknowledgement after each telegram for communication with <b>Distributed AML Server</b>.</p>



Field	Explanation
<b>Internet Address Host</b>	Address or name of host (max. 64 characters) that is allowed to communicate with AMU, indicated in the format 123.123.123.123. or <b>ANY</b> for all partner addresses possible (The name must be listed in the file C:\TCPIP\ETC\HOSTS or be available on a Domain Name Server (☞ TCP/IP Documentation).
<b>Internet Address AMU</b>	Address or name of the AMU in the TCP/IP net (max. 64 characters) that is allowed to communicate with AMU, indicated in the format 123.123.123.123. (The name must be listed in the file C:\TCPIP\ETC\HOSTS or be available on a Domain Name Server (☞ TCP/IP Documentation).
<b>Port Host</b>	Port of the AMU for communication with the Host.
<b>Port AMU</b>	Port of AMU (for internal communication). Change this port only if the port is occupied by other software.
<b>Buffer Size</b>	Size of receive buffer storage (for standard applications the default adjustment of 2048 bytes is sufficient).
<b>Connect Retry</b>	Parameter for recovering internal communication.



### Information

The parameters **Internet Address AMU** must agree with the value adjusted in the TCP/IP software.

### I7 PMAC Interface

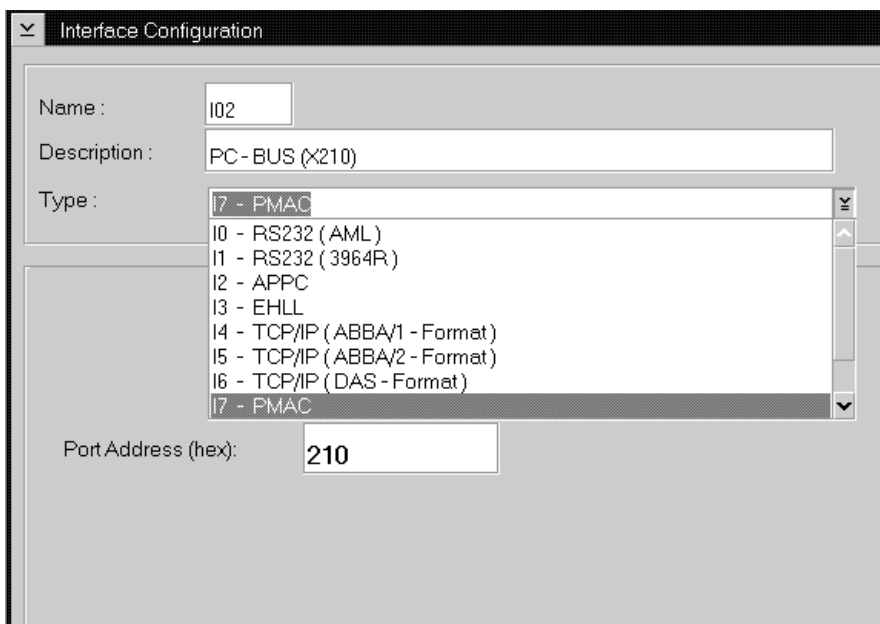

Fig. 3-55: Interface Configuration PMAC

Field	Explanation
<b>Name</b>	Automatically generated name of internal connection (I01, I02 ...).
Description	Free comment
<b>Port Address (hex)</b>	Default: 210

I8 RS232 Scanner

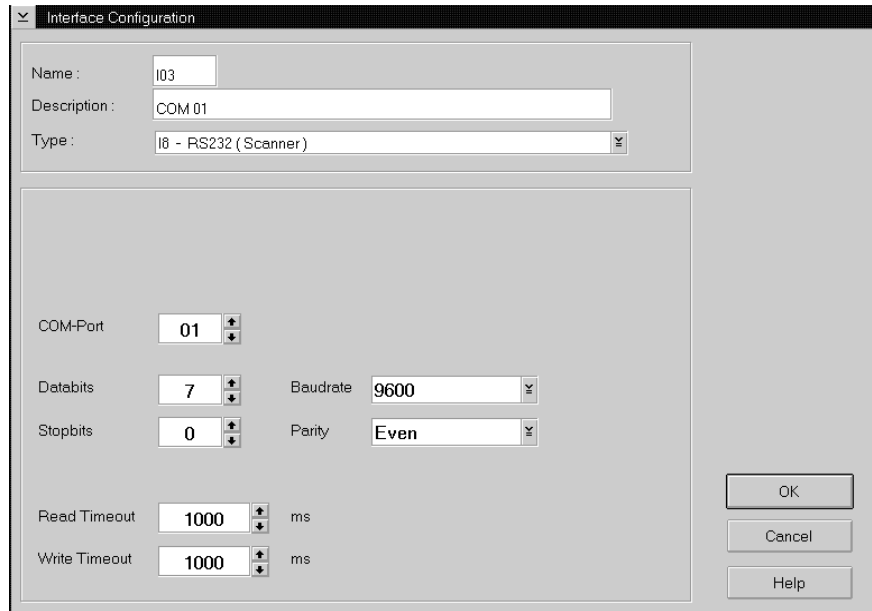

Fig. 3-56: Example RS232 Interface

Field	Explanation
<b>Name</b>	Automatically generated name of internal connection (I01, I02 ...)..
<b>Description</b>	Free comment (e.g. name of the interface "COM 02")
<b>COM-Port</b>	Hardware interface; COM port (e. g. 02)
<b>Databits</b>	Length of data byte: 7 bits
<b>Stopbits</b>	0 stop bit
<b>Parity</b>	Even ( parity even)
<b>Baudrate</b>	Baudrate: 09600
<b>Read Timeout</b>	1000 ms
<b>Write Timeout</b>	1000 ms

**I9- RS232 Interface (SOTEC Multiport)  
(RS232 (AML) Protocol + RS232 (3964 R) Protocol)**

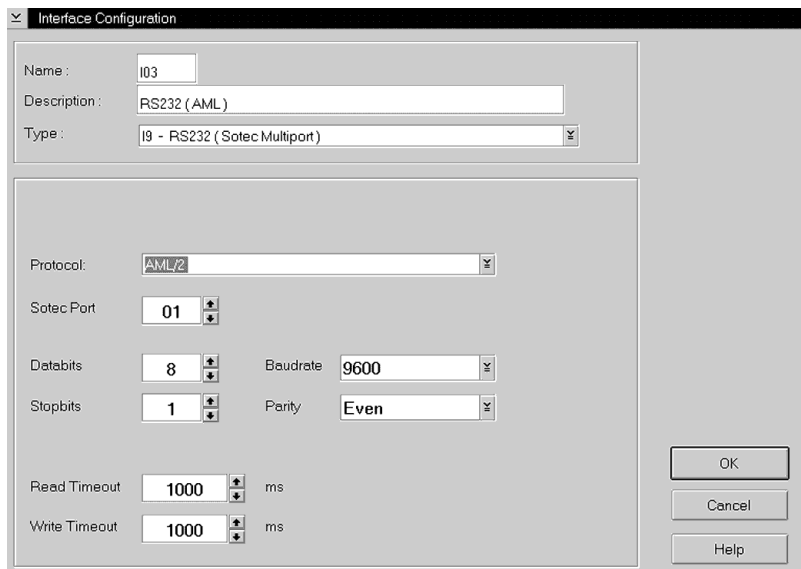

Fig. 3-57: Example RS232 Interface

Field	Explanation	
<b>Name</b>	Automatically generated name of internal connection (I01, I02 ...).	
<b>Description</b>	Free comment (e.g. name of the interface "COM 02")	
<b>Protocol</b>	AML/2 or	3964R (Siemens)
<b>Sotec-Port</b>	Hardware interface; (e. g. 02)	
<b>Databits</b>	Length of data byte: 8 bits	
<b>Stopbits</b>	2 stop bits	1 stop bit
<b>Parity</b>	None (no parity bit)	Even (even parity bit)
<b>Baudrate</b>	Baudrate: 09600	
<b>Read Timeout</b>	2000 ms	do not change
<b>Write Timeout</b>	1000 ms	do not change

### 3.11.4 Configuration Windows of Components

---



#### Information

The coordinates contain the name and the type of the respective component.

- **name:** 1st, 3rd + 4th digit of the coordinate
- **type:** 1st + 2nd digit of the coordinate

#### Example:

- **drive coordinate:** D902010101
- **name:** D02
- **type:** D9



#### Information

For storage tower, linear shelf and I/O units the various media types can be selected in the **Media Container**.

- a) Click on Media Container.  
The window **Media Container** appears.
- b) Pull the selected medium onto the desired segment or handling box with the right mouse button pressed.

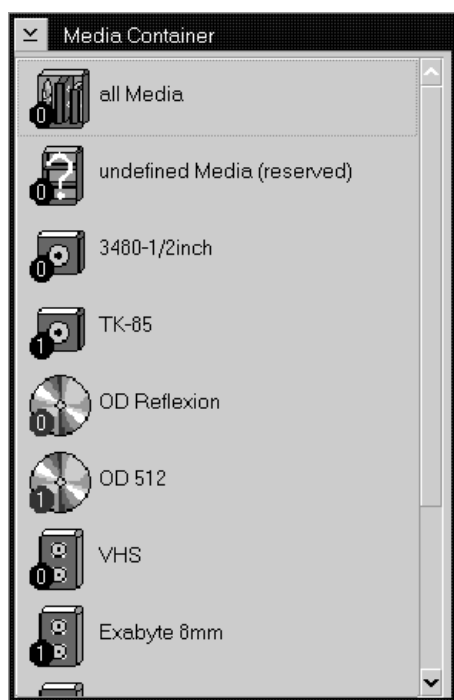

Fig. 3-58: Window Media Container

## Drive

### Information



If a large number of drives is involved, use the symbol “Container Drive” for drives connected to the same host and operated by the same robot.

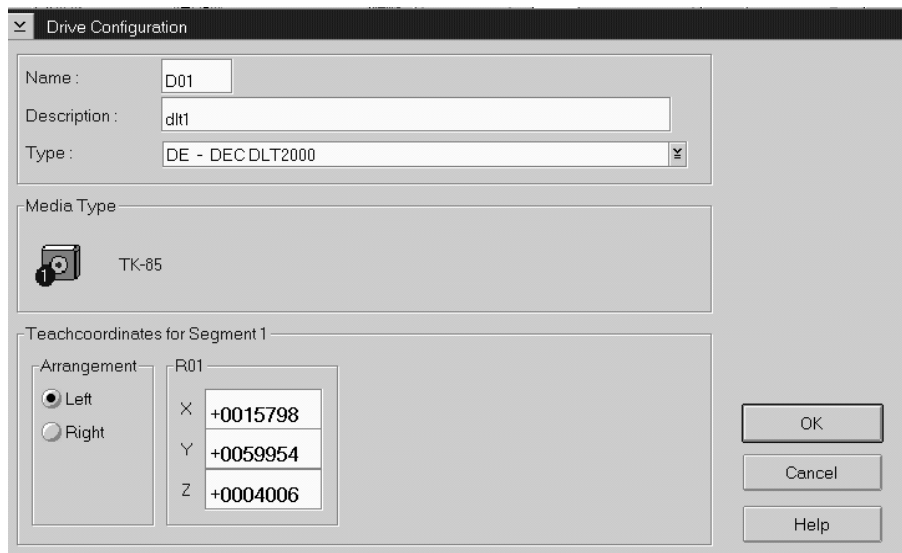

Fig. 3-59: Window Drive Configuration

Field	Explanation
<b>Name:</b>	Name of the component (D01, D02 ..., DFF).
<b>Description:</b>	Description of the component in the log strings. It would make sense to enter the drive's host address here. (For drives in a DAS environment ☞ DAS Administration Guide)
<b>Type</b>	Drive type (☞ „Drives“ from page 7-4)
<b>Arrangement</b>	Arrangement in the system.
<b>Teach coordinate R01</b>	Position of the (left) teach label on the teaching template (or teach angle for AML/J) .
<b>Media Type</b>	Symbolic representation of the storage media type to be handled (representation is based on the definition of the drive type).

### Container Drive

Folder allowing to arrange new or existing drives in a group.

Drives can be added to the folder by dragging with the mouse or with the command **Generate**.

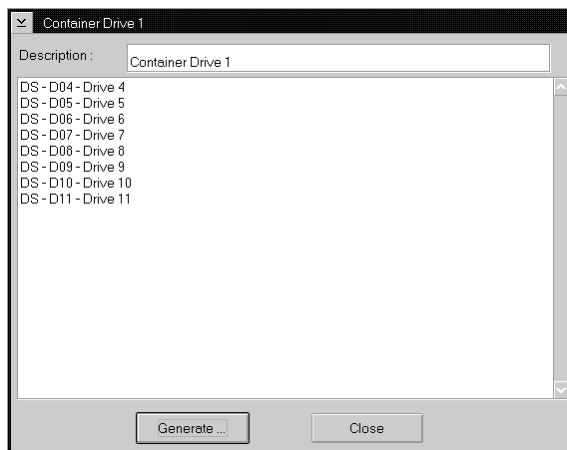

Fig. 3-60: Window "Container Drive"

Field	Explanation
<b>Description:</b>	Description of the component in the log strings. Table with all drives defined in the container drive: <ul style="list-style-type: none"><li>• drive type</li><li>• drive address (AMU)</li><li>• description (name for HACC/DAS clients)</li></ul> When you double click one line the window Drive Configuration opens (☞ Page 3-76).
<b>Generate</b>	Call up the dialog window for generation of drive configurations from the container drive
<b>Close</b>	Close the window Container Drive.

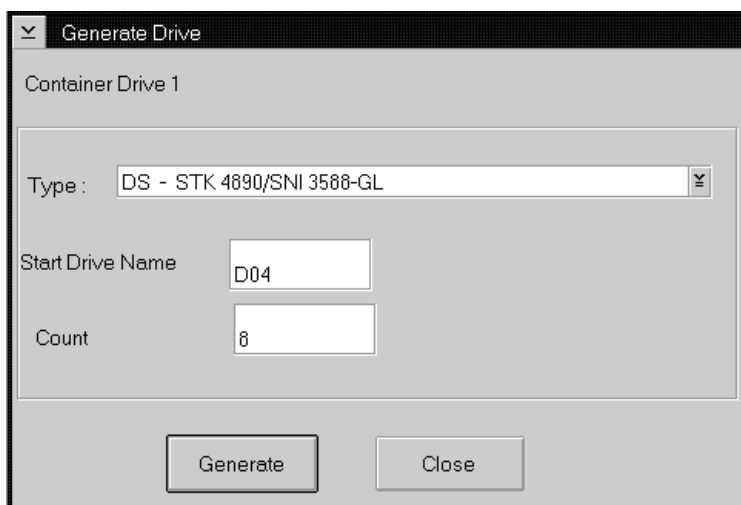

Fig. 3-61: Window “Generate Drive”

Field	Explanation
<b>Type:</b>	Select the drive type of all drive configurations to be generated in the container drive (☞ Page 7-4)
<b>Start Drive Name:</b>	Enter name of first drive in the container drive. Depending on the inputs made in the window <b>Graphical Configuration</b> the names are counted decimal or hexadecimal.
<div data-bbox="608 1312 719 1429" style="display: inline-block; vertical-align: middle;"> </div> <div data-bbox="754 1305 1289 1503" style="display: inline-block; vertical-align: middle; margin-left: 10px;"> <p><b>Information</b></p> <p><b>Generation of drive configurations will have success only if no other drives are configured for the selected range of names.</b></p> </div>	
<b>Count:</b>	Number of all drives generated in the container drive (recommended maximum number: 15)
<b>Generate</b>	Generate drive configurations with the selected parameters
<b>Close</b>	Close the window <b>Generate Drive</b>



## Host computer

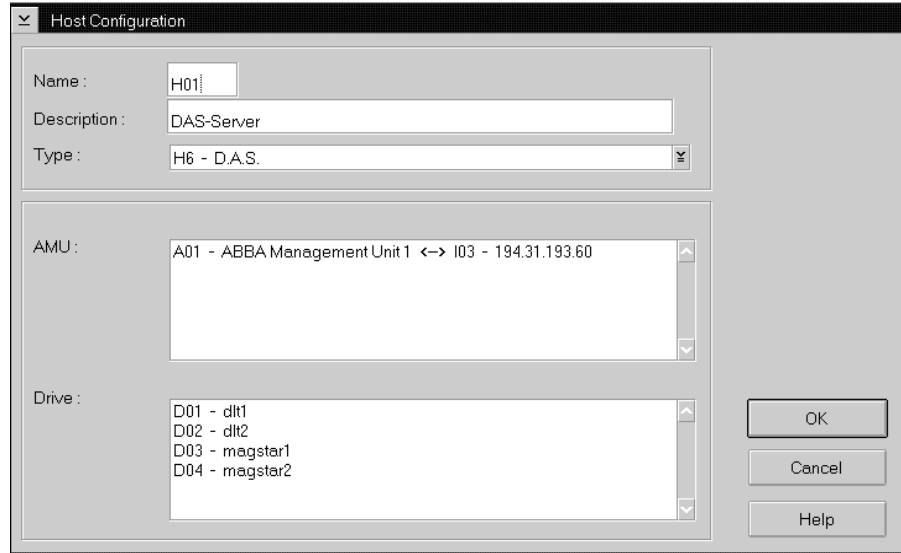

Fig. 3-62: Window "Host Configuration"

Field	Explanation
<b>Name:</b>	Name of the component (H01, H02 ...).
<b>Description:</b>	Description of the component in the log strings.
<b>Type:</b>	Component type (☞ Page 7-6)
<b>AMU:</b>	List of connected AMUs.
<b>Drive:</b>	List of connected drives.



### Information

**DAS/2-Server from version 1.3 will be not configured in the AMU.**

## Robot system

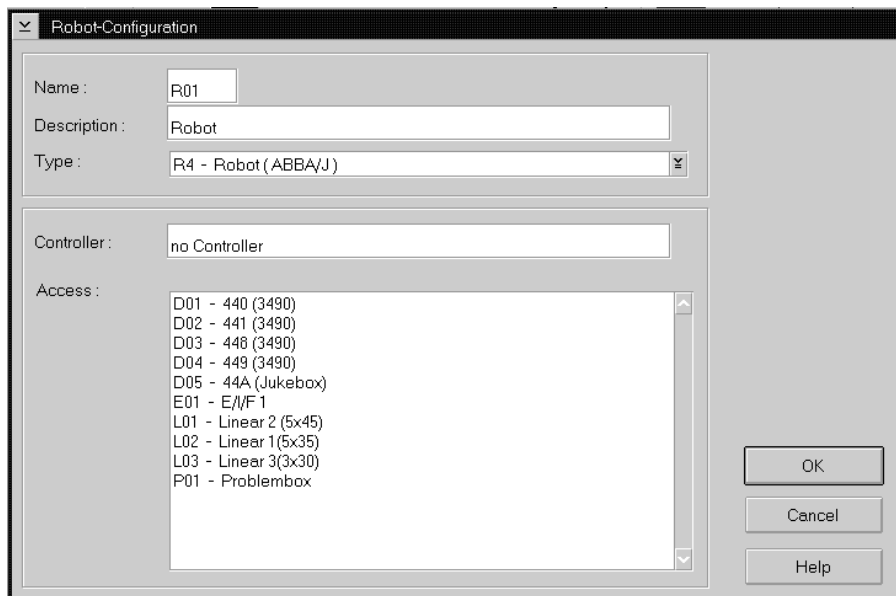

Fig. 3-63: Window "Robot Configuration"

Field	Explanation
<b>Name:</b>	Name of the component (R01, R02).  AML/E always has only one robot, AML/2 may have one or two robots.
<b>Description:</b>	Description of the component in the log strings.
<b>Type:</b>	Component type (☞ Page 7-7)
<b>Controller:</b>	Connection to controller.
<b>Access:</b>	List of units connected that can be accessed by the robot (green lines).

## Storage tower

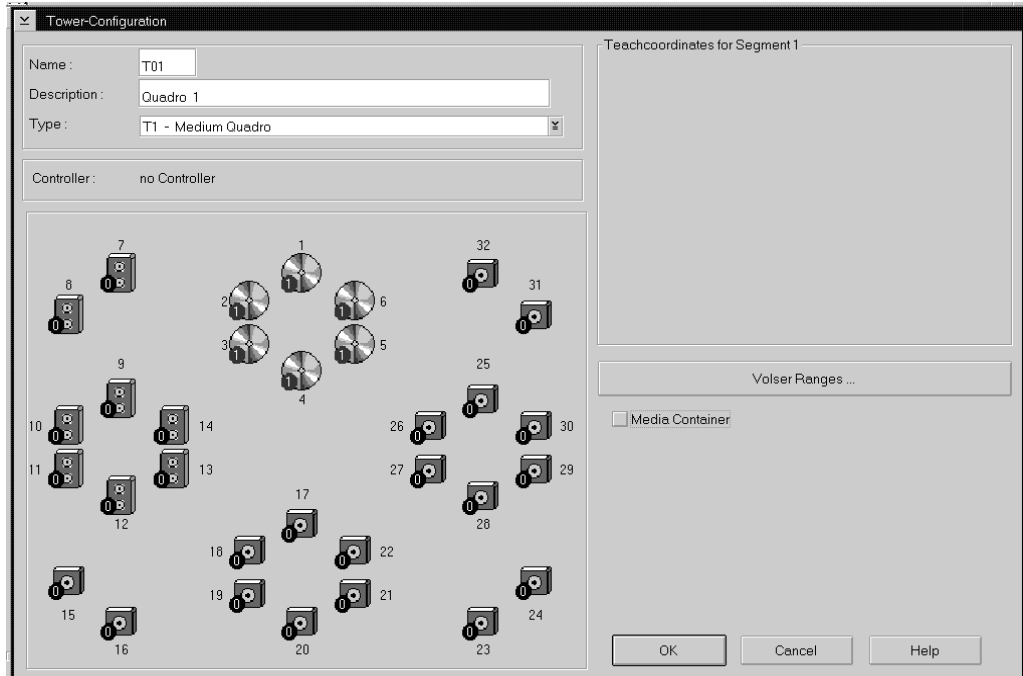

Fig. 3-64: Window "Tower Configuration"

Field	Explanation
<b>Name:</b>	Name and running number of the storage component (e. g. T01, T02, ...)
<b>Description:</b>	Description of the component in the log strings.
<b>Type:</b>	Component type (☞ Page 7-6)
<b>Controller:</b>	Connection to controller.
<b>Arrangement</b>	Arrangement of towers in the robot archive.
<b>Volser Ranges</b>	Call up configuration window for numbering ranges.
<b>Teach coordinate R01/R02</b>	Position of the bottom left teach label of robot 1 or robot 2 on twin systems.

- Volser ranges editor window

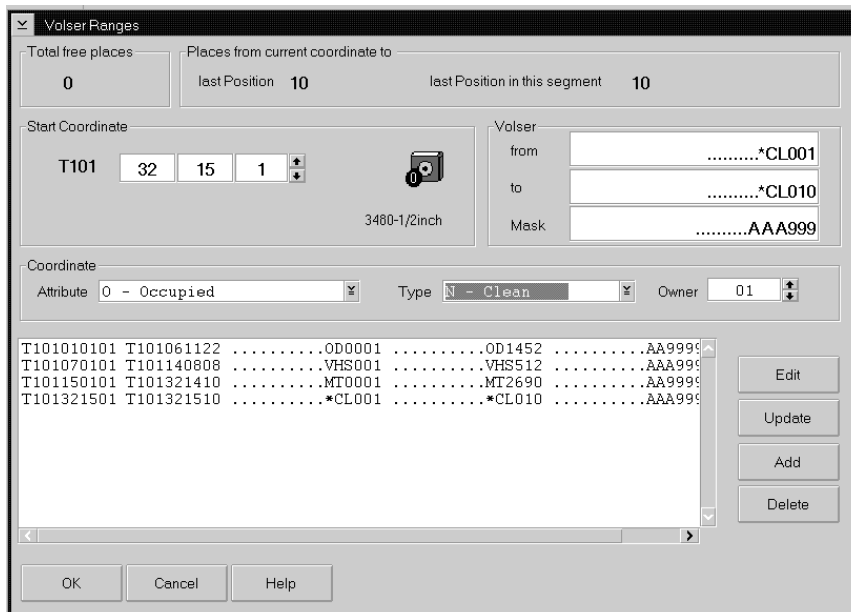

Fig. 3-65: Window "Volser Ranges"

Field	Explanation
<b>Total free Places</b>	Number of free compartments without Volser.
<b>Start Coordinate</b>	Start coordinate of a Volser range.
<b>Volser ... from</b>	First Volser of a Volser range.
<b>Volser ... to</b>	Last Volser of a Volser range.
<b>Volser ... Mask</b>	<ul style="list-style-type: none"> <li>• 9 - automatic count in the Volser</li> <li>• A - symbol, no automatic count in the Volser</li> </ul>
<b>Coord. Attr.</b>	Status of medium <ul style="list-style-type: none"> <li>• <b>0-Occupied:</b> medium occupies compartment</li> <li>• <b>E-Ejected:</b> medium has been ejected</li> <li>• <b>Y-Empty:</b> empty compartment</li> <li>• <b>M-Mounted:</b> medium in drive</li> <li>• <b>R-Reverse Side Mounted</b> (for double sided storage media)</li> <li>• <b>J-in Jukebox</b> (IBM 3995 is being served)</li> </ul>
<b>Coord. Owner</b>	Medium owner: the robot or the robots which can access this medium.

## Configuration

---

Field	Explanation
<b>Coord. Type</b>	Type of compartment <ul style="list-style-type: none"> <li>• <b>S-Storage</b>: archive compartment for hierarchically defined volser ranges or HACC-MVS management</li> <li>• <b>N-Clean</b>: cleaning medium compartment</li> <li>• <b>R-Scratch</b> range for free (scratch) media (not on HACC/MVS)</li> <li>• <b>A-AMU Dynamic</b>: home position for not hierarchically arranged compartments and temporary compartments for transit (not on HACC/MVS)</li> </ul>
<b>Update</b>	Update the marked Volser range.
<b>Edit</b>	Edit the marked Volser range.
<b>Add</b>	Create a new Volser range.
<b>Delete</b>	Delete the marked Volser range.

### Example Volser Ranges

T001010101	T001061010	A00001	A01000	A99999O 1 S
T001061101	T001311010	B00001	B04500	A99999O 1 S
T001231101	T001321710	C00001	C00250	A99999E 1 S
T001321801	T001321810	CL0001	CL0010	AA9999O 1 N

### Example Volser Ranges (cleaning cartridges without barcode label)

T001321801	T001321810	*CL001	*CL010	AAA999O 1 N
------------	------------	--------	--------	-------------

## Controller

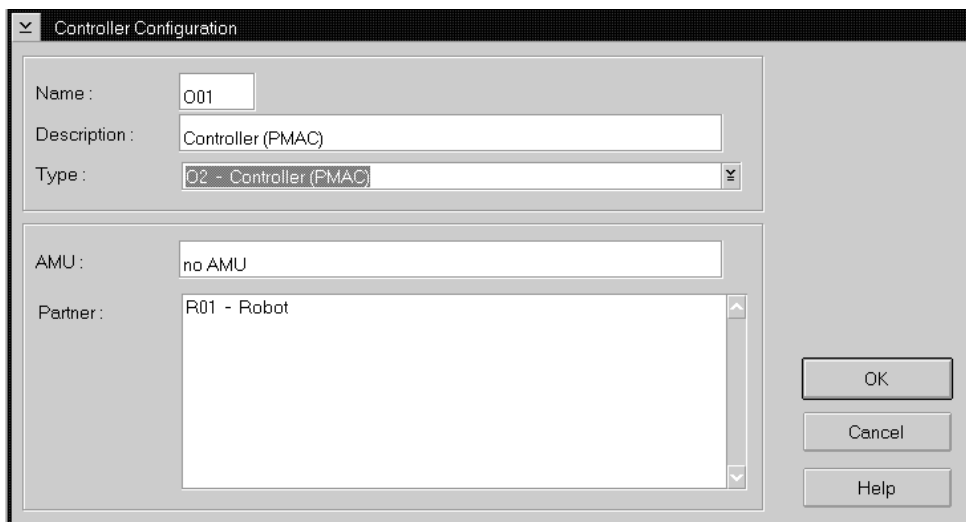

Fig. 3-66: Window "Controller Configuration"

Field	Explanation
<b>Name:</b>	Name of component (O01, O02 ...).
<b>Description:</b>	Description of the component in the log strings.
<b>Type:</b>	Component type: (☞ „Control Units“ from page 7-7)
<b>AMU:</b>	List of connected AMUs (default A01).
<b>Partner:</b>	List of connected units.

### Problem box

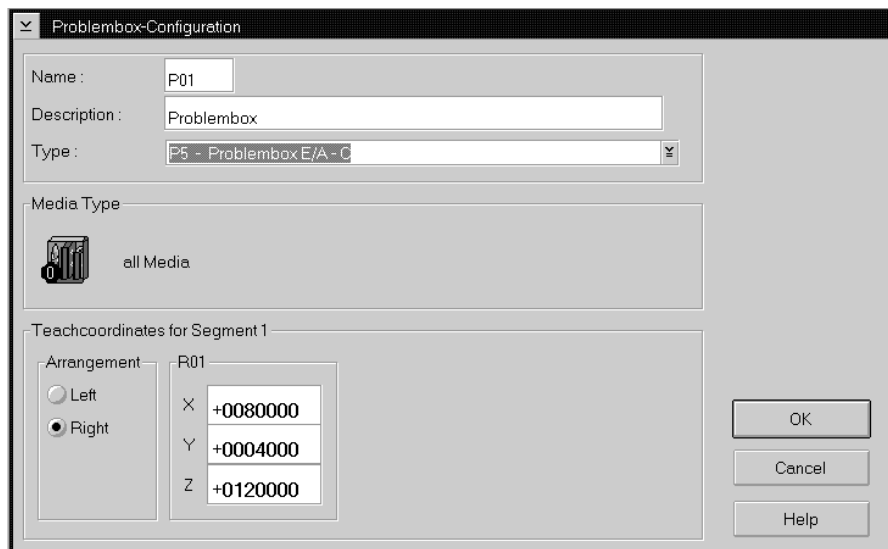

Fig. 3-67: Window "Problembox Configuration"

Field	Explanation
<b>Name:</b>	Name of component: (P01, P02)
<b>Description:</b>	Description of the component in the log strings.
<b>Type:</b>	Component type (☞ „I/O Units“ from page 7-6)
<b>Arrangement</b>	Arrangement in the system.
<b>Teach coordinate</b>	Position of the left teach label on the problem box.

## AMU

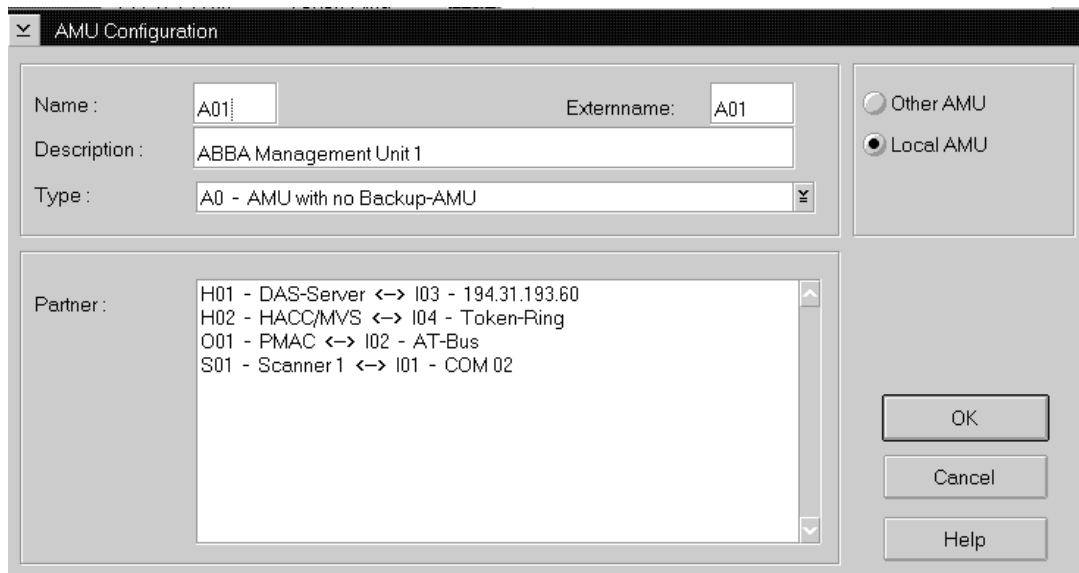

Fig. 3-68: Window "AMU Configuration"

Field	Explanation
<b>Name:</b>	Name of component (A01, A02 ...).
Externname:	Name for the telegrams to the connected hosts (actual operate all hosts with the name A01)
<b>Description:</b>	Description of the component in the log strings.
<b>Type:</b>	Component type <ul style="list-style-type: none"> <li>• A0: AMU without dual AMU</li> <li>• A1: dual AMU (AMU(A) and AMU(B))</li> <li>• A2: AMU as backup AMU (not used anymore as of version 2.3)</li> </ul>
<b>Local AMU</b>	Configuration of local AMU hardware.
<b>Other AMU</b>	Configuration of AMU connected to local AMU.
<b>Partner:</b>	List of connected communication partners.



## I/O unit

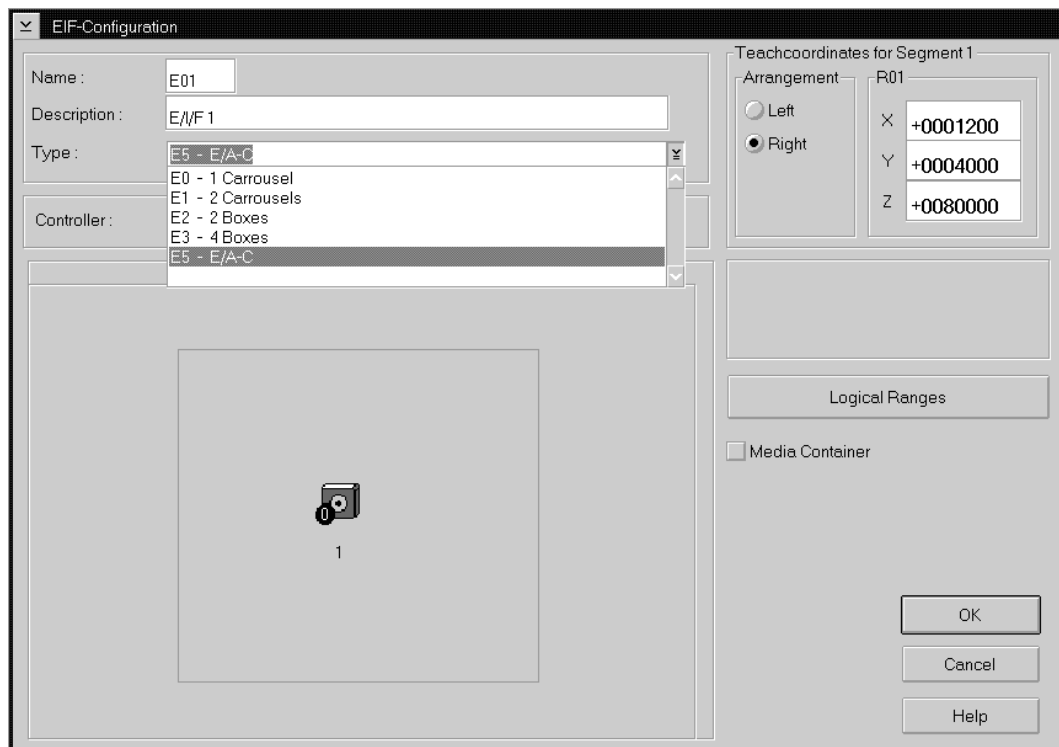

Fig. 3-69: Fenster "E//F Configuration"

Field	Explanation
<b>Name:</b>	Name of component (E01, E02 ...).
<b>Description:</b>	Description of the component in the log strings.
<b>Type:</b>	Component type (☞ „I/O Units“ from page 7-6)
<b>Controller:</b>	Connected controller
<b>Arrangement</b>	Arrangement in the system.
<b>Teach coordinate</b>	Position of bottom left teach label on the top handling box (seen from inside).
<b>Logical Ranges</b>	Call up the configuration window for the numbering ranges.

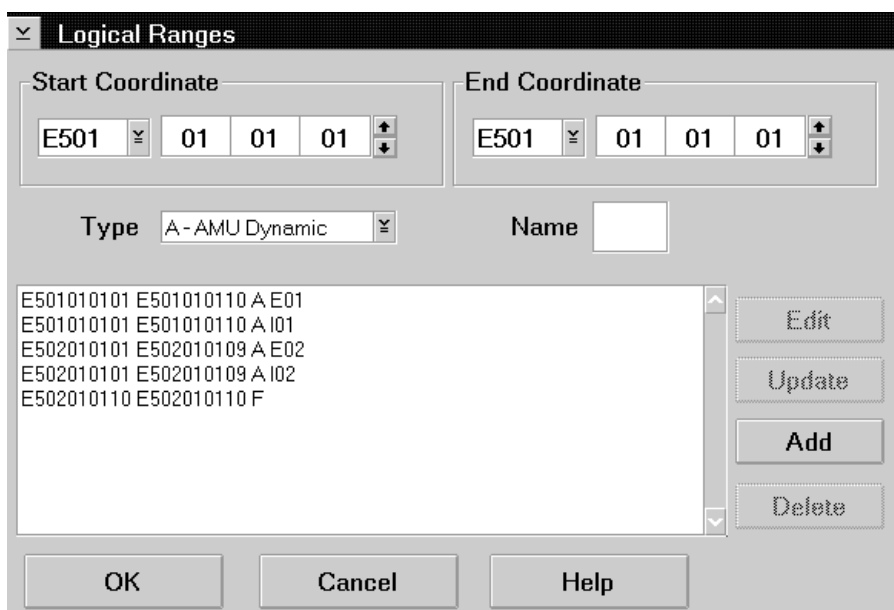



Fig. 3-70: Window “Logical-Ranges” (Example AML/2 I/O Unit/B)

Field	Explanation
<b>Start Coordinate</b>	Start coordinate of a Volser range.
<b>End Coordinate</b>	End coordinate of a Volser range.
<b>Name</b>	Short name for command execution (only AMU Dynamic)
	<p><b>Information</b></p> <p> <b>Assign names for consecutive ranges. If a name is assigned twice, only the first range is addressed by the software.</b></p>
<b>Coord. Type</b>	Type of compartment <ul style="list-style-type: none"> <li>• <b>F-Foreign:</b> archive compartment for foreign media</li> <li>• <b>D-HACC Dynamic:</b> range only for HACC/MVS</li> <li>• <b>A-AMU Dynamic:</b> range for input and output of certain host software</li> </ul>
<b>Update</b>	Update the marked Volser range.
<b>Edit</b>	Edit the marked Volser range.
<b>Add</b>	Create a new Volser range.
<b>Delete</b>	Delete the marked Volser range.

## Configuration

Host Software	Types for I/O Unit		
	Foreign	HACC-Dynamic	AMU-Dynamic
HACC/MVS	Compartments defined as foreign in the host software. The Volsers must be defined from *11001 - *22999.	All compartments for input and output	----
HACC/VM	Compartments to be used for foreign mount. The Volsers must be defined from *FR001 - *FR299.	-----	Compartments for eject Names: E01 (eject robot 1) E02 (eject robot 2) I01 (insert robot 1) I02 (insert robot 2)
ROBAR			
HACC/GUARDIAN			
HACC/OS400			Compartments for dynamic use for insert and eject, overlapping is possible.  Names *)  Insert: Ixx Eject: Exx
DAS 1.2	Compartments are automatically defined by DAS commands with  *10001-*10099		
DAS 1.3	Compartments to be use for foreign by DAS. The volser will automatically assigned to the coordinate  e.g. *E101030301		

\*) When the name E01 is used, this range is used as standard insert and eject area by ROBAR, HACC/VM etc.

Example **Logical Ranges** (without host database, e. g. ROBAR and HACC/VM)

```
E001010101    E001010310    A    I01
E001020101    E001020210    A    E01
E001020301    E001020310    F
```

Example **Logical Ranges** (with host database, only on HACC/MVS)

```
E001010101    E001020210    D
E001020301    E001020310    F
```

## Linear shelf

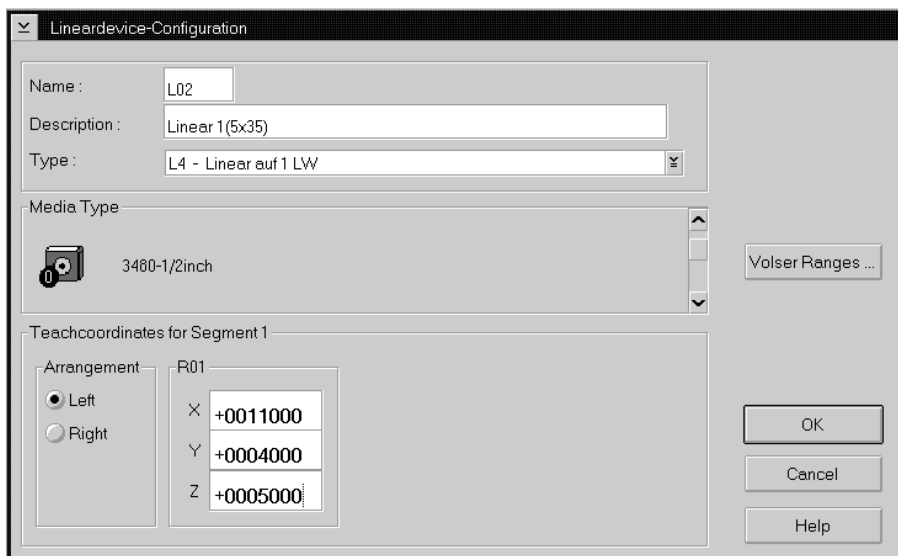

Fig. 3-71: Window "Lineardevice-Configuration"

Field	Explanation
<b>Name:</b>	Name of storage component with running number (e. g. T01, L02, ...)
<b>Type:</b>	Component type (☞ „Storage Units“ from page 7-6)
<b>Controller:</b>	Connection to controller.
<b>Description:</b>	Description of the component in the log strings.
<b>Arrangement</b>	Arrangement in the system.
<b>Volser Ranges</b>	Call up the configuration window for the numbering ranges.
<b>Arrangement</b>	Arrangement of the systems in the robot archive.
<b>Teach coordinate R01</b>	Position of bottom left teach label.

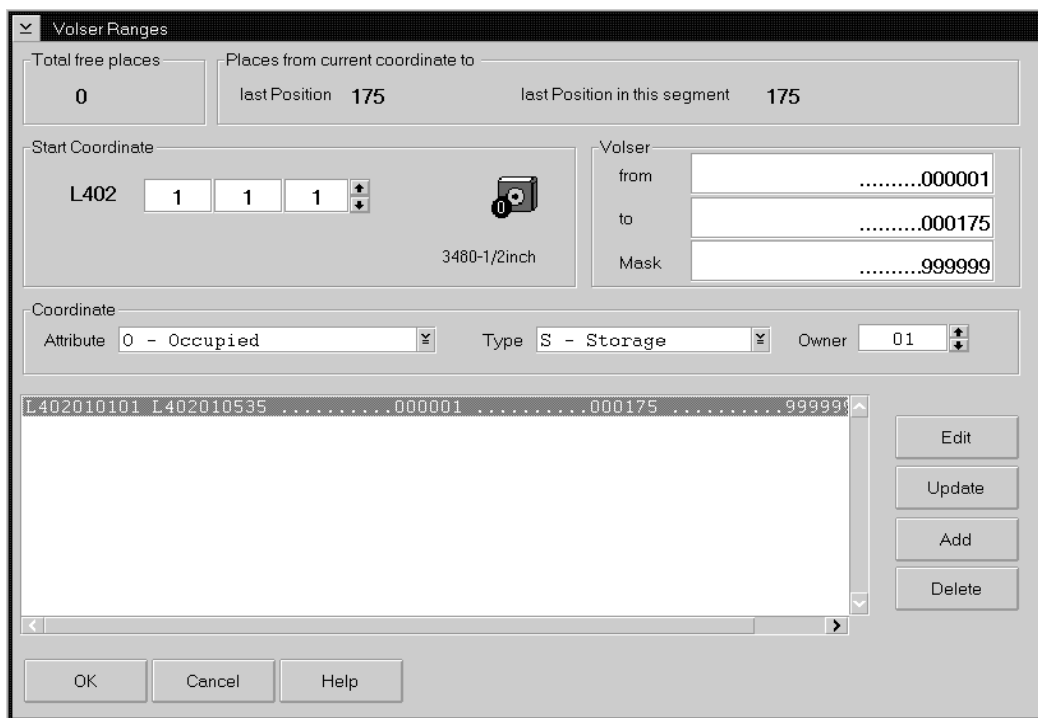

Fig. 3-72: Window "Volser Ranges" for Linear Shelf AML/J

Field	Explanation
<b>Total free Places</b>	Number of free compartments without Volser.
<b>Start Coordinate</b>	Start coordinate of a Volser range.
<b>Volser ... from</b>	First Volser of a Volser range.
<b>Volser ... to</b>	Last Volser of a Volser range.
<b>Volser ... Mask</b>	<ul style="list-style-type: none"> <li>• 9 - automatic count in the Volser</li> <li>• A - symbol, no automatic count in the Volser</li> </ul>
<b>Coord. Attr.</b>	Status of the mediums <ul style="list-style-type: none"> <li>• <b>0-Occupied</b>: medium occupies compartment</li> <li>• <b>E-Ejected</b>: medium has been ejected</li> <li>• <b>Y-Empty</b>: empty compartment</li> <li>• <b>M-Mounted</b>: medium in drive</li> <li>• <b>R-Reverse Side Mounted</b> (for double sided storage media)</li> <li>• <b>J-in Jukebox</b> (IBM 3995 is being served)</li> </ul>
<b>Coord. Owner</b>	Medium owner: the robot that can access this medium.

Field	Explanation
<b>Coord. Type</b>	Type of compartment <ul style="list-style-type: none"> <li>• <b>S-Storage</b>: archive compartment for hierarchically defined volser ranges or HACC-MVS management</li> <li>• <b>N-Clean</b>: cleaning medium compartment</li> <li>• <b>R-Scratch</b> range for free (scratch) media (not on HACC/MVS)</li> <li>• <b>A-AMU Dynamic</b>: home position for not hierarchically arranged compartments and temporary compartments for transit (not on HACC/MVS)</li> </ul>
<b>Update</b>	Update the marked Volser range.
<b>Edit</b>	Edit the marked Volser range.
<b>Add</b>	Create a new Volser range.
<b>Delete</b>	Delete the marked Volser range.

### Example Volser Ranges

L402010101    L402010101    000001    000175    999999O 1 S

### ADS Automatic Data Switch

- automatic switch-over between the dual-AMUs
- the switch-over is prompted by a host command

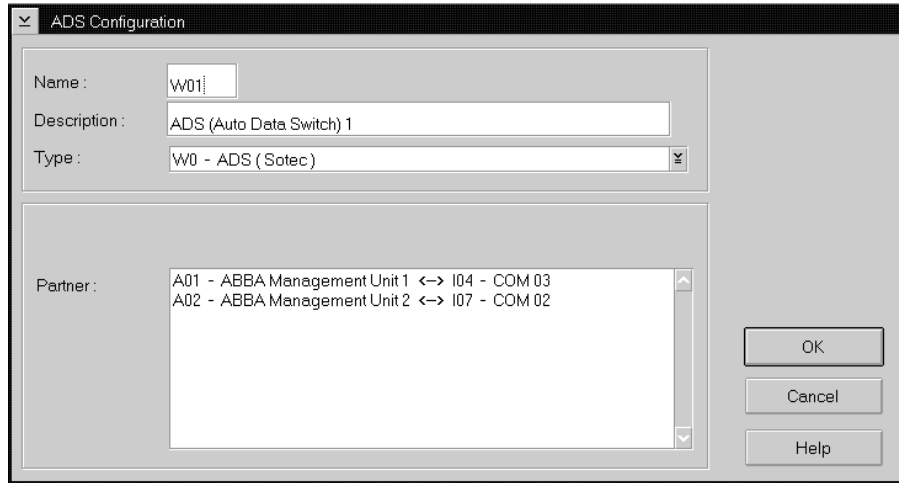

Fig. 3-73: Window "ADS Configuration"

Field	Explanation
<b>Name:</b>	Name of component (W01)
<b>Description:</b>	Description of the component in the log strings
<b>Type:</b>	Component type <ul style="list-style-type: none"><li>• W0 - ADS (SOTEC)</li></ul>
<b>Partner:</b>	List of connected AMUs

### Configuration of an AML System with Dual-AMU and Automatic Data Switch

- a) Insert a second icon “AMU” in the configuration.
- b) Insert the icon “ADS”.
- c) Create a connection from AMU(A) to AMU(B).
- d) Create a connection from AMU(B) to AMU(A).



#### Information

**Check, that one of the connections is from A01 to A02 and the other connection from A02 to A01 . This are nessecary for display the actual connections of the AMU. If nothing or both connections marked, create the configurations of the connections new.**

- e) Create connections from AMU(A) to each Host.
- f) Create connections from AMU(B) to each Host.
- g) Create connections from AMU(A) and AMU(B) to each controller (Control Tower, Control Robot, Control I/O Unit/A).
- h) Create connections from AMU(A) and AMU(B) to the ADS.



Abb. 3-74: Window “Graphical Configuration” with Dual-AMU and ADS



i) Setup the following values in the window **AMU configuration**

Field	Parameter AMU(A)	Parameter AMU(B)
<b>Name:</b>	A01	A02
<b>Externname:</b>	A01	A01
<b>Description:</b>	AML Management Unit1	AML Management Unit2
<b>Type:</b>	A1-AMU with Backup-AMU	A1-AMU with Backup-AMU
<b>Other AMU</b>		4
<b>Local AMU</b>	4	

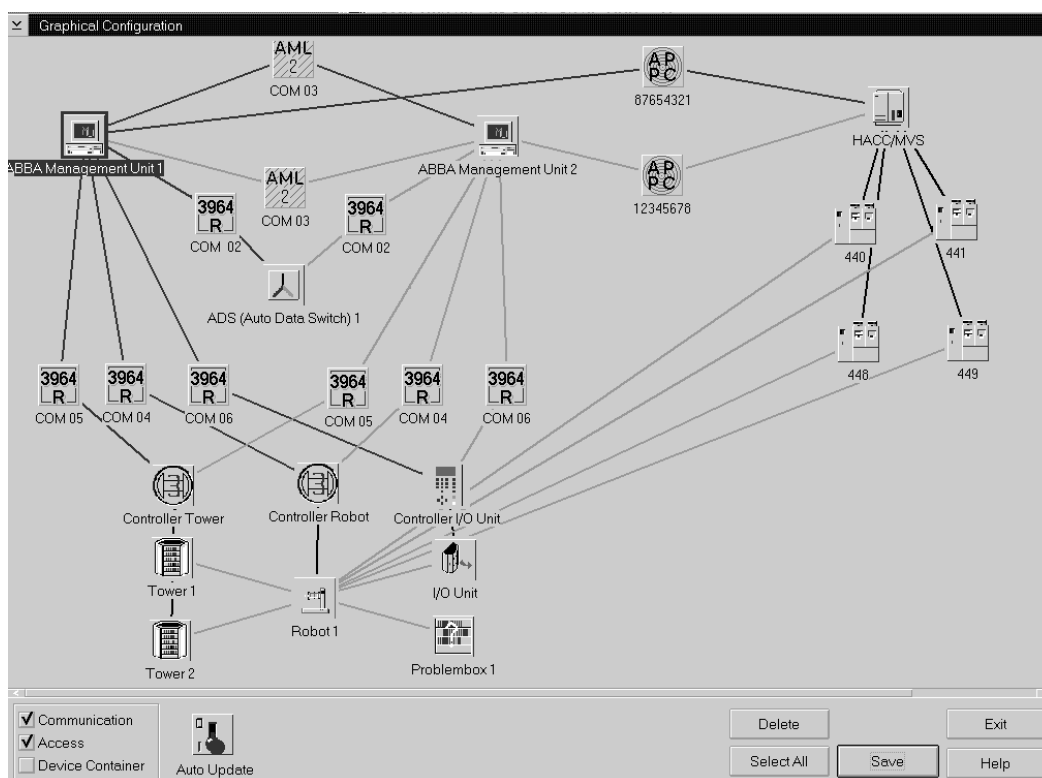
j) On the PC AMU(A) create the file LOCAL.AMU in directory C:\AMU with the content A01.

k) On the PC AMU(B) create the file LOCAL.AMU in directory C:\AMU with the content A02.



### Information

**Use the same interfaces for AMU(A) and AMU(B).**

l) Configure communication paths between

- the AMUs
- AMU and Host
- AMU and Controller

m) Save the new adjustments with **Save**.

n) Restart AMU.

### Meaning of the file LOCAL.AMU

The configuration parameters are saved on both AMUs. The assignment of the active communication parameters is made using the AMU names (A01 or A02). This name appears in the ASCII-file LOCAL.AMU in the directory C:\AMU.

**Scanner (barcode reading system only for AML/J)**

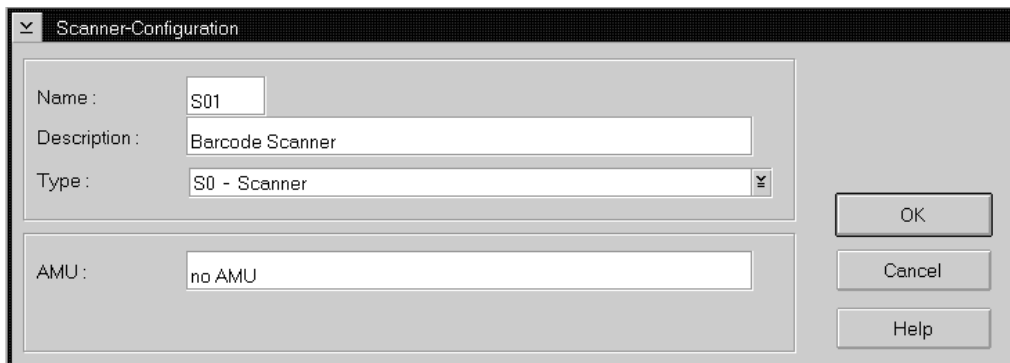

*Fig. 3-75: Window "Scanner-Configuration"*

Field	Explanation
<b>Name:</b>	Name of component (S01)
<b>Description:</b>	Description of the component in the log strings
<b>Type:</b>	Component type <ul style="list-style-type: none"> <li>• S0 - Scanner</li> </ul>
<b>AMU:</b>	Indicates connected AMU

### 3.12 Trace Levels

---

#### 3.12.1 HOC-Trace (Communication)

---

Trace-Level	Configuration
HOC0	HOC process (modules)
HOC1	Event control
HOC2	TCP/IP communication
HOC3	Siemens 3964R communication with control
HOC4	APPC communication
HOC5	RHO3 protocol 4 robot communication (not used on AML/E)
HOC6	AML2 communication, Siemens host, dual-AMU
HOC7	RHO3 protocol 4 tower communication (not used on AML/E)
HOC8	RS422 communication for ABBA/1 tower communication (only on ABBA/1)
HOC9	EHLL communication (HACC 3174/3274 terminal emulation)

### 3.12.2 CON-Trace (Operating Console)

Trace Level	Configuration
CON0	Load dialogs
CON1	not used
CON2	Communication with kernel
CON3	Communication with kernel (telegram exchange)
CON4	Log processes
CON5	Multi-purpose
CON6	Configuration server 1
CON7	Configuration server 2
CON8	Configuration server 3
CON9	Incoming events of a partner to the CON module

### 3.12.3 KRN-Trace (Central Logic)

---

Trace Level	Configuration
KRN0	Module: bottom functional level of kernel, send/receive kernel events
KRN1	Inputs/outputs of kernel (host communication)
KRN2	Internal error situation
KRN3	communication between KRN and CON
KRN4	Command queue of AMU/L
KRN5	AMU queue and robot selection
KRN6	Internal processes of AMU/P1 (ABBA/1)
KRN7	Processes of AMU/P1 (AML/2)
KRN8	Physical coordinates of teach processes
KRN9	Processes of AMU/P2 (AML, commands to robots, towers, I/O unit)

### 3.12.4 ART-Trace (Log- and Trace Functions)

Trace Level	Configuration
ART0	not used
ART1	Event control
ART2	not used
ART3	not used
ART4	not used
ART5	not used
ART6	not used
ART7	not used
ART8	not used
ART9	not used

### 3.12.5 ARC-Trace (Archive Catalog Management)

Trace Level	Configuration
ARC0	Event control
ARC1	Database query
ARC2	Database change
ARC3	Creation of database
ARC4	Changes in the I/O unit
ARC5	Edit Volser ranges
ARC6	not used
ARC7	Backup
ARC8	Journaling
ARC9	Restore

### 3.12.6 BUD-Trace (Data Transfer to Dual-AMU)

---

Trace Level	Configuration
BUD0	Initializing, termination
BUD1	Events received and corresponding data
BUD2	Events sent and corresponding data
BUD3	Queue (read, write, delete)
BUD4	File transfer (start, stop)
BUD5	Database access (read, update)
BUD6	Synchronization with communication partner (PING, ACT ON/OFF)
BUD7	Time set access (start, stop, queue)
BUD8	Check of data received
BUD9	not used

**3.12.7 DAS-Trace (Diagnosis for DAS/2 Version 1.3)**

<b>Trace Level</b>	<b>Configuration</b>
DAS0	Communications between RPC and ACI
DAS1	Communications between DAS and RQM
DAS2	Communications between RQM and AMU
DAS3	Detail about DAS Function IN/OUT
DAS4	Detail about RQM Function IN/OUT
DAS5	DAS Data
DAS6	RQM Data
DAS7	DAS Error
DAS8	RQM Error
DAS9	RQM Timer and others



## 4 Utilities

---

### 4.1 Rho File Manager

---

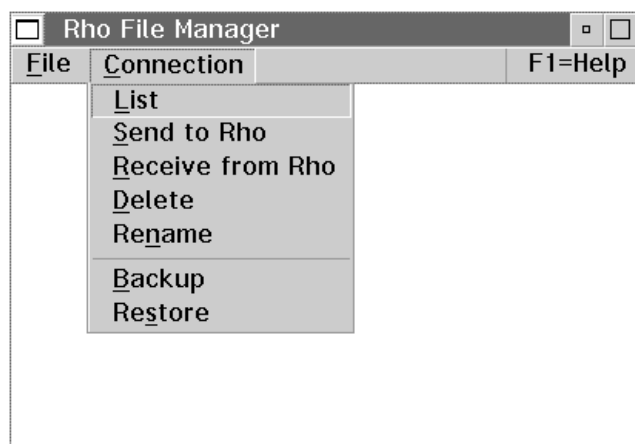

*Fig. 4-1: Window "Rho File Manager" Overview*

The Rho File Manager transfers files between AMU and the rho control units in both directions.

It is required for initial operation and maintenance jobs.

### 4.1.1 Starting the Rho File Manager

---



#### **ATTENTION!**

**Before starting the Rho File Manager stop the communication between host and AMU.**

#### **During operation**

- a) Start the Rho File Manager only when:
- the main program of the rho control is running  
(on AML/E output 0.0 is flashing)
  - there are no errors (query with PHG mode 7.2)

After a safety query the robot moves to its initial position and the AMU function stops (kernel is terminated).

#### **After booting the control system**

- a) Start the Rho File Manager only directly after a reset of the rho control (e. g. upon start) without <CONTROL ON>.  
The AMU function stops (kernel is terminated).

### 4.1.2 Menu File

---

Command	Explanation
<b>About</b>	Display copyright information and version number.
<b>Exit</b>	Exit Rho File Manager.



#### Information

##### After exiting the Rho File Manager

- **the interface for data communication with AMU is automatically configured**
- **the AMU kernel restarts**

4.1.3 Menu Connection

Command	Field	Explanation
List		Display contents of rho control.

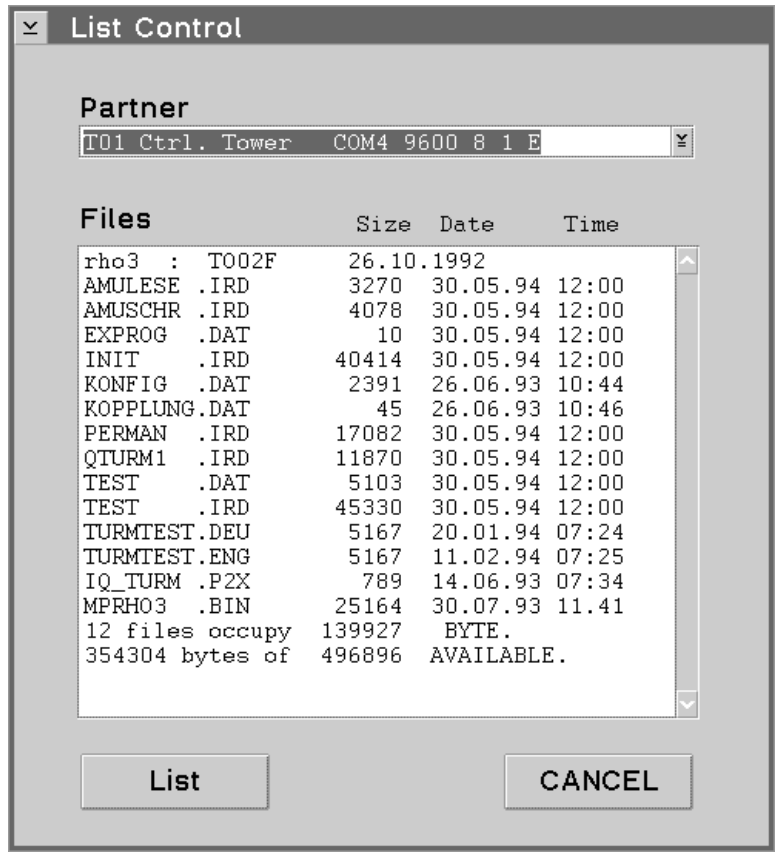

Fig. 4-2: Window "List Control"

**Partner** Select partner (rho control) with a double click. It may take a few seconds to activate the connection.



**Information**

**If no partner has been selected you are prompted for a selection.**

Command	Field	Explanation
<b>List</b> (continued)	<b>Files</b>	<p>Display all stored files with</p> <ul style="list-style-type: none"> <li>file size - can differ between rho and PC for the files *.DAT and *.P2X (different storage mode for zeros)</li> <li>issue date</li> </ul> <p>Information on</p> <ul style="list-style-type: none"> <li>operating system version</li> <li>storage engagement</li> </ul>
	<b>List</b>	Update the display.
<b>Send to Rho</b>		Send one or more files to the rho control.

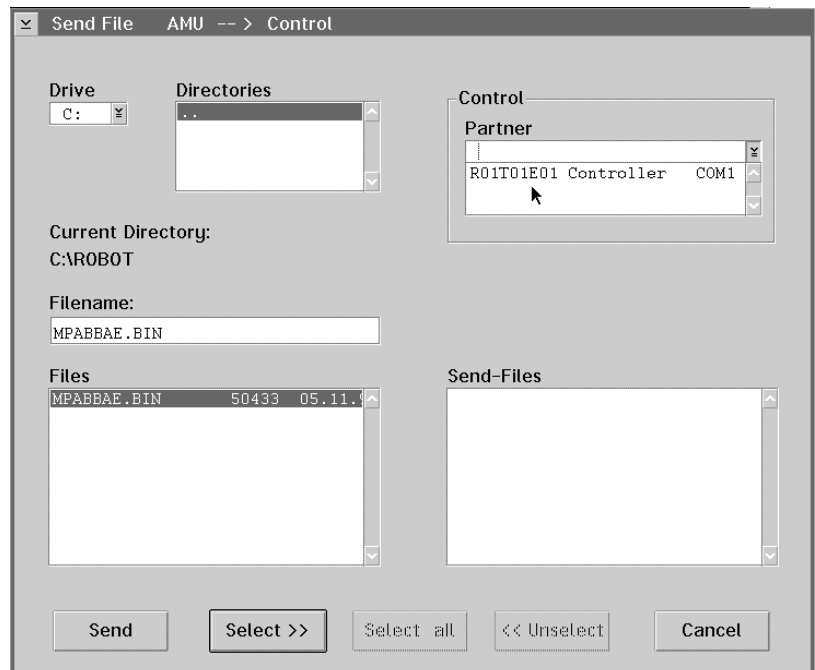

Fig. 4-3: Window "Send File AMU --> Control"



### ATTENTION!

**Transfer only files required by rho. Other or additional files can cause failures.**



### Information

**Before transferring files \*.BIN or \*.P2X you must actuate the write-protect switches at the control unit (☞ WHB).**

Command	Field	Explanation
<b>Send to Rho</b> (continued)	<b>Drive</b>	Select the drive.
	<b>Directories</b>	Display all directories of current drive.
	<b>Current Directory</b>	Display the current directory path.
	<b>Filename</b>	Enter <ul style="list-style-type: none"> <li>• filename</li> <li>• search criterion with variables (*, ?)</li> <li>• absolute or relative path with final “\” (e. g. <b>c:\amu\</b>)</li> </ul>
	<b>Files</b>	Display files in the <b>Current Directory</b> .
	<b>Partner</b>	Select partner (rho control) with a double click. It may take a few seconds to activate the connection.
		
	<b>Overwrite</b>	Overwrite files with identical names during transfer. Files with file extension DAT are excluded.
	<b>Send Files</b>	Display files to be sent.

Command	Field	Explanation
Send to Rho (continued)	Send	Send selected files. 
	Select	Select marked files for transfer.
	Select all	Select all files for transfer that match the search criterion entered under <b>Filename</b> .
	Unselect	Unselect the files already selected for transfer.

Fig. 4-4: Window "Send AMU --> Control"

- **Actual Status** The bar indicates the bytes transferred. The overall length corresponds to the file size.
- **Filename** File information of current transfer.
- **Files** Transfer status
  - **Okay** successful transfer
  - **Error** error during transfer
  - **Existed** existing file has not been overwritten

Command	Field	Explanation
<b>Receive from Rho</b>		Transfer one or more files from rho to AMU.

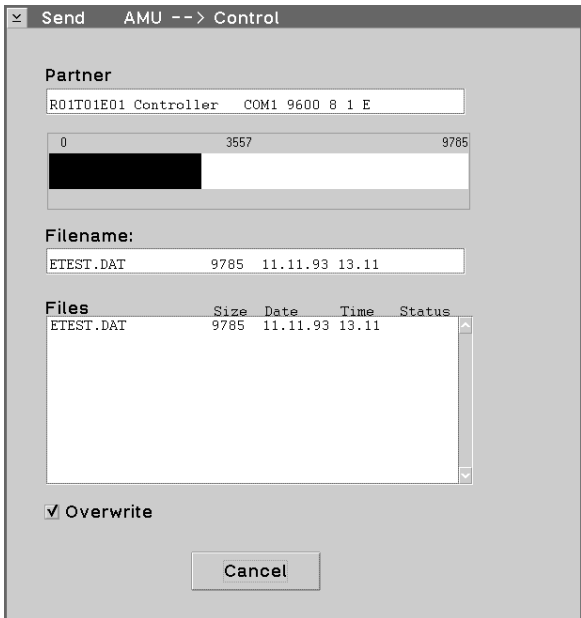

**Information**

The file “MPRHO3.BIN” appears in the window only after the command List has been used.

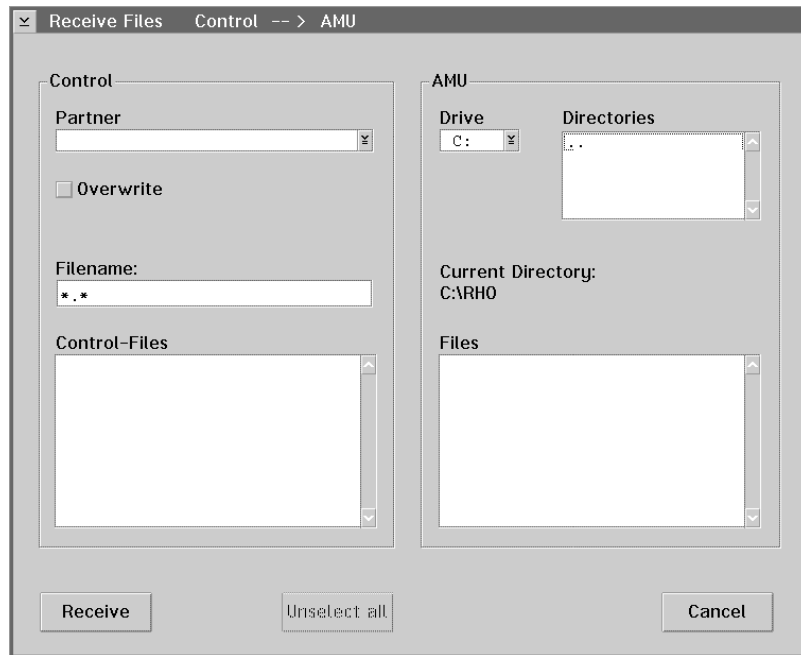

Fig. 4-5: Window “Receive Files Control --> AMU”

**Partner** Select partner (rho control) with a double click. It may take a few seconds to activate the connection.



**Information**

If no partner has been selected you are prompted for a selection.

**Overwrite** Overwrite files with identical names during transfer. Files with file extension DAT are excluded.

**Filename** Display the current file.



Command	Field	Explanation
<b>Receive from Rho</b> (continued)	<b>Control-Files</b>	Display files in rho. Marked files are transferred.
	<b>Drive</b>	Select the drive.
	<b>Directories</b>	Display all directories on the current drive.
	<b>Current Directory</b>	Display the current directory path.
	<b>Files</b>	Display files in the <b>Current Directory</b> .
<b>Receive</b>		Transfer the selected files.
		
<b>Unselect all</b>		Unselect all files selected for transfer.

Fig. 4-6: Window "Receive Control --> AMU"

- **Actual Status** The bar indicates the bytes transferred. The overall length corresponds to the file size.
- **Filename** File information of current transfer.
- **Files** Transfer status
  - **Okay** successful transfer
  - **Error** error during transfer
  - **Existed** existing file has not been overwritten

Command	Field	Explanation
Delete		Delete a file in rho.

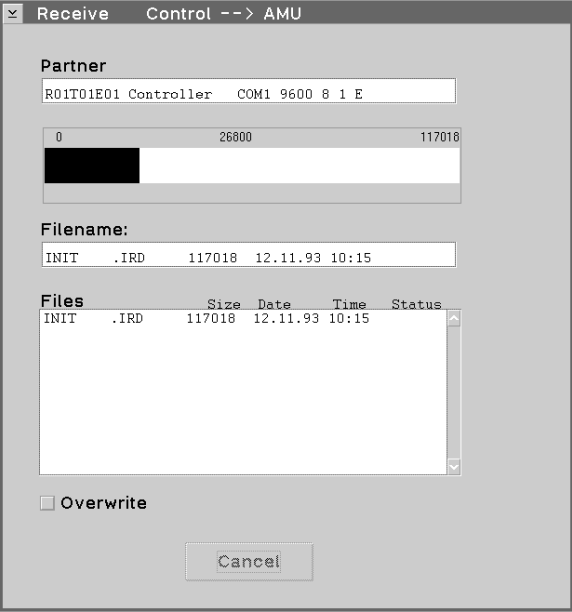
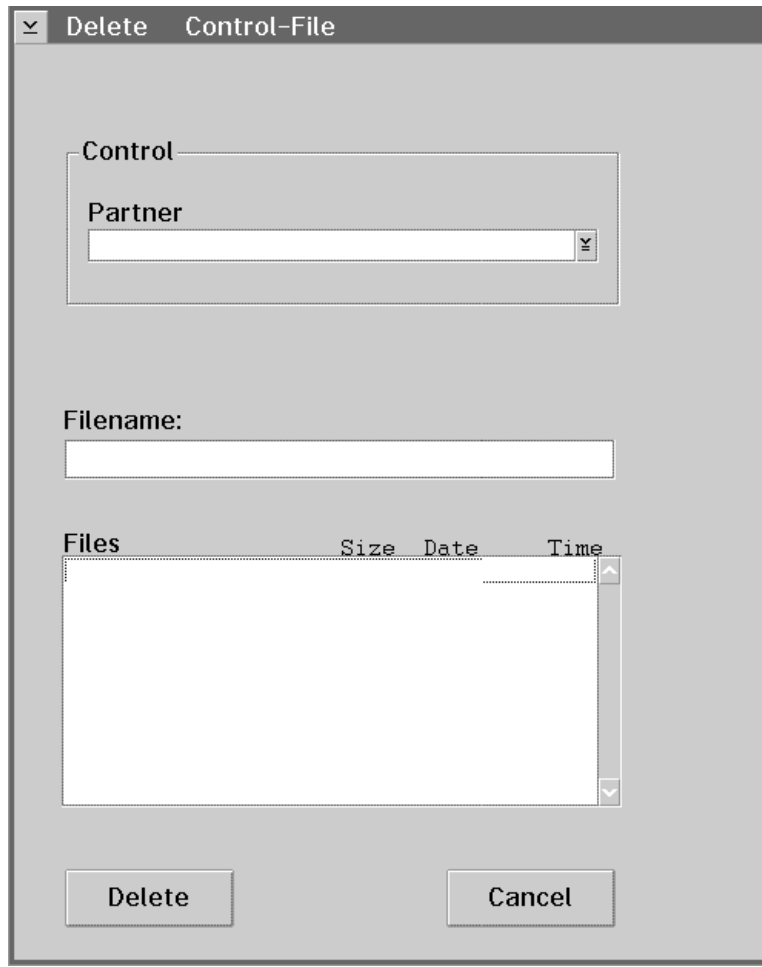

Fig. 4-7: Window "Delete Control-File"

**Partner** Select partner (rho control) with a double click. It may take a few seconds to activate the connection.



**Information**

**If no partner has been selected you are prompted for a selection.**

**Filename** Enter

- filename
- search criterion with variable (\*, ?)

Command	Field	Explanation
<b>Delete</b> (continued)	<b>Files</b>	Display files in rho. Marked files are deleted.  Exceptions: files with the extensions BIN and P2X.
	<b>Delete</b>	Delete the marked file.
<b>Rename</b>	Rename files in rho.	

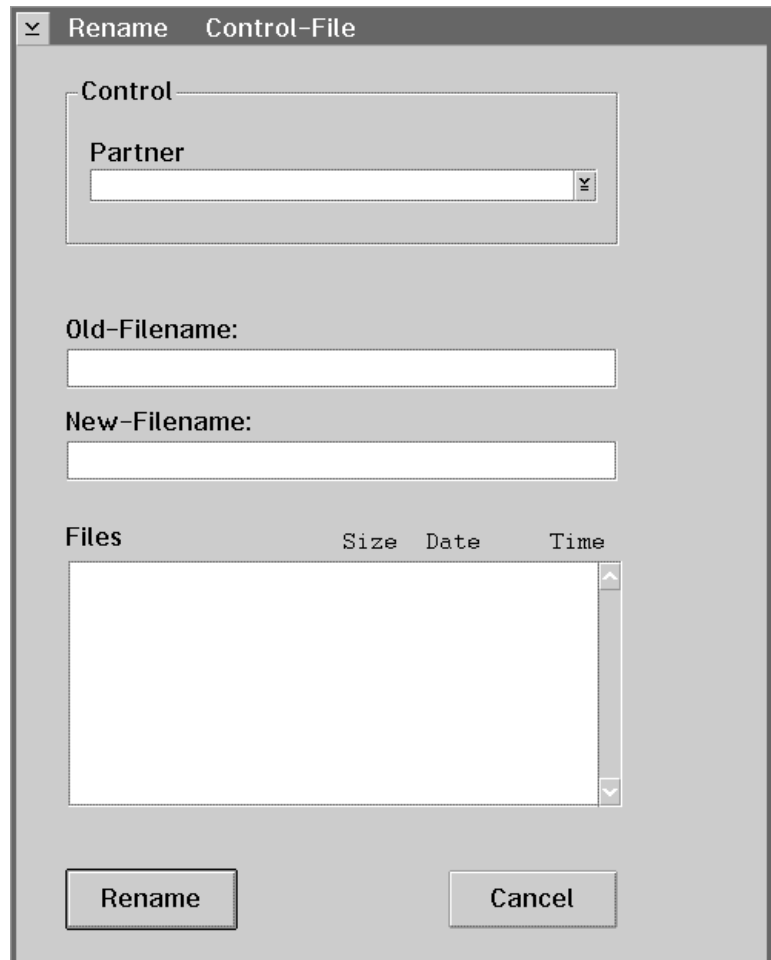



Fig. 4-8: Window "Rename Control-File"



**ATTENTION!**

Active files and files required by rho must not be renamed. This could lead to failures.

Command	Field	Explanation
<b>Rename</b> (continued)	<b>Partner</b>	Select partner (rho control) with a double click. It may take a few seconds to activate the connection.
		 <b>Information</b> <b>If no partner has been selected you are prompted for a selection.</b>
	<b>Old-Filename</b>	Select the file to be renamed.
	<b>New-Filename</b>	Enter new filename.
	<b>Files</b>	Display files in rho.
	<b>Rename</b>	Rename the file.
<b>Backup</b>		Backup all files in rho to AMU.

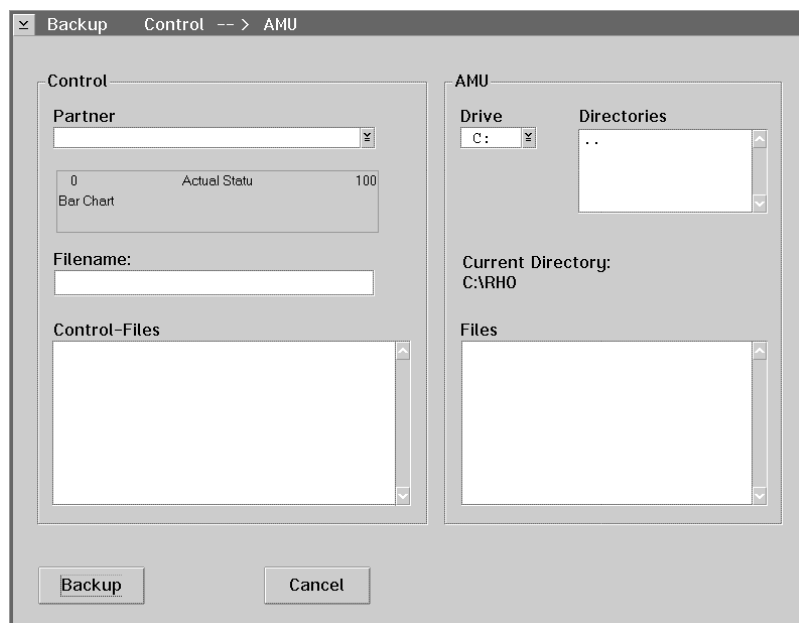



Fig. 4-9: Window "Backup Control --> AMU"

Command	Field	Explanation
<b>Backup</b> (continued)	<b>Partner</b>	Select partner (rho control) with a double click. It may take a few seconds to activate the connection.
		<div style="display: flex; align-items: center;">  <div> <p><b>Information</b></p> <p><b>If no partner has been selected you are prompted for a selection.</b></p> </div> </div>
	<b>Filename</b>	During the transfer the file currently transferred is displayed.
	<b>Control-Files</b>	Display files in rho. Marks are without meaning.
	<b>Drive</b>	Select drive.
	<b>Directories</b>	Display all directories on the current drive.
	<b>Current Directory</b>	Display the current directory path.
	<b>Files</b>	Display files in the <b>Current Directory</b> .
	<b>Backup</b>	Backup all files.  The window "Receive Control --> AMU" appears.

Command	Field	Explanation
<b>Restore</b>		Restore all files stored in the AMU directory to rho (e. g. after replacing board).



**Information**

**Before starting restore you must actuate the write-protect switches at the control unit (👉 WHB).**



**Information**

**First restore files with the extension \*.BIN to rho. These define the storage to the correct size.**

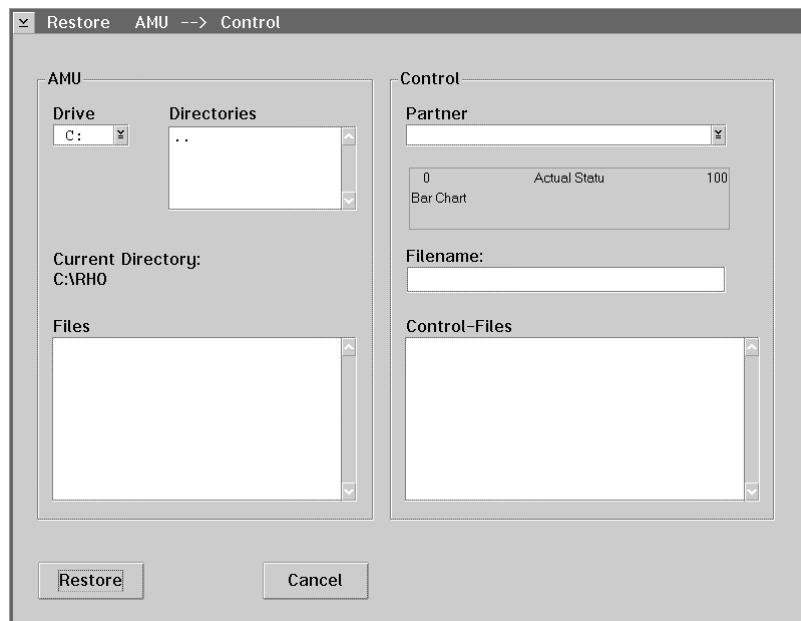

*Fig. 4-10: Window "Restore AMU --> Control"*

- Drive**                      Select the drive.
- Directories**            Display all directories on the current drive.
- Current Directory**      Display the current directory path.
- Files**                      Display files in the **Current Directory**.

Command	Field	Explanation
<b>Restore</b> (continued)	<b>Partner</b>	Select partner (rho control) with a double click. It may take a few seconds to activate the connection.
		 <p><b>Information</b></p> <p><b>If no partner has been selected you are prompted for a selection.</b></p>
	<b>Filename</b>	During the transfer the file currently transferred is displayed.
	<b>Control-Files</b>	Display files in rho. Marks are without meaning.
	<b>Restore</b>	Restore all files in the AMU directory to rho.  The window “Send AMU --> Control” appears

## 4.2 “JUSTUTIL.EXE”

AML/E and AML/2 only

### Information

Use Justutil only for AML/2 and AML/E.

Editor for the teach point files “KRNREFPT.R01” and “KRNREFPT.R02”.  
With “JUSTUTIL.EXE” you can move individual teach points. The values are saved in the teach point file “KRNREFPT.R01” or “KRNREFPT.R02”.

### Information

Insert all values in 1/100 mm.

### Start “JUSTUTIL.EXE”

- a) Open an OS/2 window
- b) Enter the following commands:  

```
[C:\]cd amu
```

```
[C:\amu]justutil
```

The window “JustUtil.exe” appears:



Fig. 4-11: Window “JustUtil.exe”



**Commands**

AML/E and AML/2 only

Command	Field	Description
<b>Update</b>	Changes individual teach point coordinates..	
		
	<b>Robot</b>	Robot connected
	<b>Type</b>	Component type
	<b>Number</b>	Number of the component
	<b>Segment</b>	Segment number
	<b>Up Left</b>	Coordinates of the top left teach label
	<b>Down Left</b>	Coordinates of the bottom left teach label
	<b>Down Right</b>	Coordinates of the bottom right teach label
	<b>Correction</b>	Unchangeable correction values. Even upon reteaching, these values are retained. Used for instance for drives of the same type but of different condition (old - new).
	<b>X-Coor.</b>	Longitudinal coordinate (X) in 1/100 mm
	<b>Y-Coor.</b>	Transverse coordinate (Y) in 1/100 mm
	<b>Z-Coor.</b>	Vertical coordinate (Z) in 1/100 mm
	<b>Update</b>	Changes individual teach point coordinates. Update becomes active only after a restart.

Fig. 4-12: Window “Update Teachpoints”

AML/E and AML/2 only

Command	Field	Description
<b>Move</b>		Move teach points of a component at once, e. g. for moving a complete tower.
		
	<b>Robot</b>	Robot connected
	<b>Type</b>	Component type
	<b>Number</b>	Number of component
	<b>Segment</b>	Segment number
	<b>Down Left</b>	Coordinates of the bottom left teach label
	<b>X-Coor.</b>	Longitudinal coordinate (X)
	<b>Y-Coor.</b>	Transverse coordinate (Y)
	<b>Z-Coor.</b>	Vertical coordinate (Z)
	<b>all</b>	All teach points
	<b>single</b>	Individaul teach point
	<b>towers</b>	All teachpoints of the storage towers
	<b>tapedevs</b>	All teachpoints of the drives
	<b>linear</b>	All teachpoints of the linear shelves
	<b>Move</b>	Starts moving the teach points

Fig. 4-13: Window “Move Teachpoints”

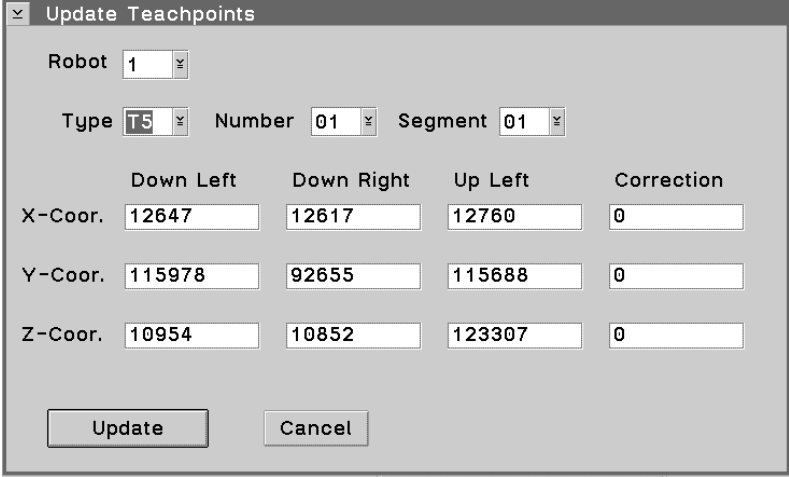
AML/E and AML/2 only

Command	Field	Description
---------	-------	-------------

<b>Rename</b>		Change the name of a teachpoint e.g. for change drive addresses.
---------------	--	--

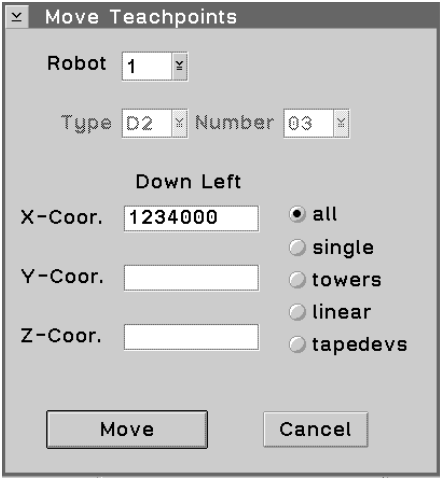
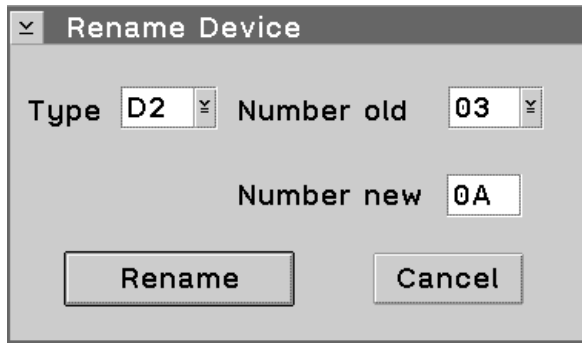

Fig. 4-14: Window “Rename Teachpoints”

Type	Component type
Number old	Number of component before rename
Number new	Number of component after rename

<b>Delete</b>		Deletes a teach point.
---------------	--	------------------------

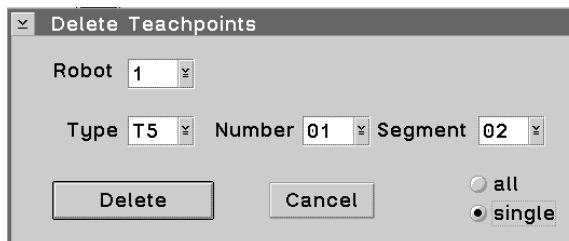

Fig. 4-15: Window “Delete Teachpoints”

Robot	Robot connected
Type	Component type
Number	Number of component
<b>Delete</b>	Deletes the teach point

Command	Field	Description
List	Lists all teach points of the system..	
		
	Robot	Robot connected
	OK	Closes the window “List Teachpoints”.

Fig. 4-16: Window “List Teachpoints”

### Activate changes in the list of teach points

- Terminate “JUSTUTIL.EXE” by a double click on the system menu field
- Terminate AMU with **Shutdown AML...**  
The “CMD.EXE” window appears
- Restart AMU. Enter the following in the “CMD.EXE” window  
[C:\amu] startup
- Test the handling
- After teaching transfer the changed teach-point file to the backup or dual-AMU (only if available) (QVW S. 3-51) and save this file on diskette.

### 4.3 LOG2ASC

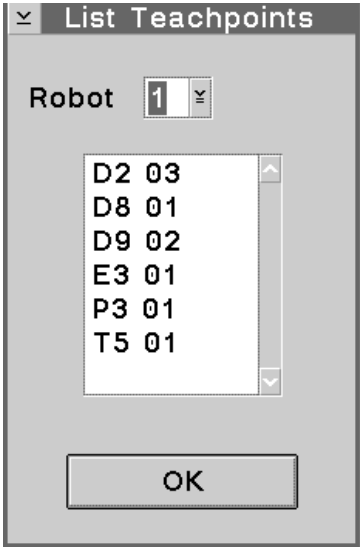
---

Tool converting the binary Log-File in the directory C:\AMU\LOGS-TRC into the ASCII-format.

#### Syntax

```
[drive][path]log2asc <logfile> [outfile] [msgfile]
```

Parameter	Explanation
logfile	Path and filename of the AMU log file to be converted in binary format
outfile	Path and filename of the ASCII log file to be generated Default: log2asc.out
msgfile	Path and name of the file with the texts of the AMU system Default: c:\AMU\AMU.MSG

#### Example

```
c:\amu\log2asc c:\amu\logs-trc\log3011.001 log3011.txt
```

#### Structure of Log-Filename:

- Identifier: **log**
- Date with zeros: e. g. **3011**
- Count number: e. g. **001**

### 4.4 AMU Archive Catalog (Database)

---

#### 4.4.1 Database Destroyed - What to do?

---



##### Information

**Always switch the Database Backup in window Process Configuration to active. This minimizes the damage when a problem with the database occurs.**

Before working with the database try to save it

- database backup
  - database export
- a) Check the AMU log for SQL error messages.
  - b) Test whether the Database Manager still reacts to AMU queries:  
In the **View** menu select the command **View Archive**
  - c) Find out what exactly has been damaged
    - special SQL errors
    - the database
    - the database and the Database Manager
    - the harddisk of the AMU processor (all data on the harddisk)

##### Speical SQL error message

*SQL0818N A timestamp conflict occured*

- a) Stop the AMU software (**shutdown AML...**).
- b) Open an OS/2 window.
- c) Enter `logon /1 amuadmin /p=xxxxxxx`  
(logon as AMU administrator, xxxxxx = password).
- d) Change to the AMU directory (`cd amu`).
- e) Enter `arcbandit` (database and AMU are linked).
- f) Start the AMU (`startup`).

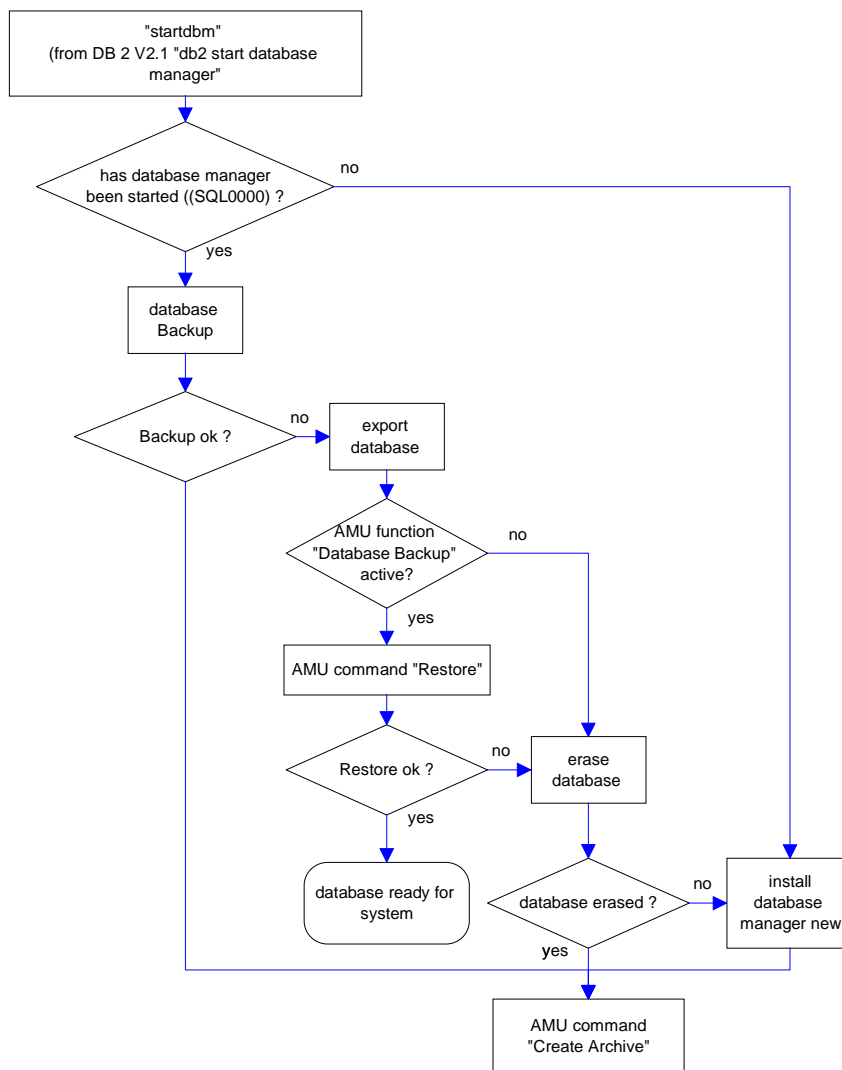

Fig. 4-17: Procedure "Restore database"

g) The further steps depend on the configuration of your system

HACC/MVS	Dual AMU	DB Backup	Archive Type	How to proceed
yes	yes or no	yes		a) In the <b>Service</b> menu select the command <b>Create Archive</b> .  If this command does not function, perform a "Download" from HACC.

## AMU Archive Catalog (Database)

HACC/MVS	Dual AMU	DB Backup	Archive Type	How to proceed
yes or no	yes	no		<p>a) In the <b>Service</b> menu select the command <b>Archive - Restore</b>.</p> <p>If this function should not work proceed as described for “DB Backup”.</p>
yes or no	yes	no		<p>a) Switch over to the backup AMU with the host command ROSA (the dual-AMU takes over the full function until the AMU with the defective database functions again).</p> <p>b) Repair the defective AMU.</p> <p>c) After repair start the computer as passive AMU (all changed data records are automatically transferred).</p>
yes	no	no		<p>a) Unload the media from the drives and hand-carry them into the archive.</p> <p>b) In the <b>Service</b> menu select the command <b>Create Archive</b>.</p> <p>c) Start the Download from HACC.</p>
no	no	no	hierarchical	<p>a) Unload the media from the drives and hand-carry them into the archive.</p> <p>b) In the <b>Service</b> menu select the command <b>Create Archive</b>.</p> <p>c) In the <b>Commands</b> menu select the command <b>Inventory</b> for the entire archive - 1st coordinate - last coordinate</p> <p>d) Manually resolve the discrepancies. Use the log files to trace them.</p>
no	no	no	dynamic	<p>a) Unload the media from the drives and hand-carry them into the archive.</p> <p>b) In the <b>Service</b> menu select the command <b>Create Archive</b>.</p> <p>c) In the <b>Commands</b> menu select the command <b>Inventory</b> for the entire archive - 1st coordinate - last coordinate - <b>Option AU</b></p>



### 4.4.2 Backup of the Database

---



#### Information

**Prepare some formatted diskettes. The backup requires a lot of storage space.**

- a) Select **Shutdown AML...**  
The kernel is terminated, the archive catalog no longer accessible.
- b) Change to the OS/2 desktop.
- c) Open an OS/2 window.



#### Information

**For help with command syntax enter `dbm ?`.**

- d) Enter `startdbm` (the Database Manager starts).



#### Information

**By entering the command `dbm stop using database` ensure no process will try to access AMU.**

**If necessary, enter command `dbm select database AML`**

- e) Enter `logon /l amuadmin /p=xxxxxxx`  
(logon as AMU administrator, xxxxxx= password).
- f) Put the first diskette into the target drive.



#### Information

**As of DB/2 version 2.1 a memory size must be entered together with the command:**

`dbm backup database AML to a buffer 16`

**The prompt for diskette change is the message SQL2059 “A device full warning ... (c/d/t)”.**

**After inserting a new diskette, confirm the message by typing “c”.**

- g) Enter `dbm backup database AML to a`.
- h) Restart AMU (QVW 5-2)
  - open an OS/2 input window and enter “startup” or
  - perform a system shut-down and a restart thereafter

### 4.4.3 Restoring the Database

---

- a) Select **Shutdown AML...**  
The kernel is terminated, the archive catalog no longer accessible.
- b) Change to the OS/2 desktop.
- c) Open an OS/2 window.
- d) Enter `startdbm` (the Database Manger is started)



#### Information

**By entering the command `dbm stop` using database ensure no process will try to access AMU.**

- e) Enter `logon /l amuadmin /p=xxxxxxx`  
(logon as AMU administrator, xxxxxx= password).
- f) Put the first backup diskette into the drive A:  
Depending on the size of the archive catalog several diskettes may be required.



#### Information

**As of DB/2 version 2.1 a memory size must be entered together with the command:**

`dbm restore database AML from a buffer 16`

**The prompt for diskette change is the message SQL2059 “A device full warning ... (c/d/t)”.**

**After inserting a new diskette, confirm the message by typing “c”.**

- g) Enter `dbm restore database AML from a to c`.
- h) Restart AMU (QVW 5-2)
  - open an OS/2 input window and enter “startup” or
  - perform a system shut-down and a restart thereafter

### 4.4.4 Edit Volser Ranges

---

#### Terms

Coordinate Range: connected compartments in a storage system (e. g. storage tower, I/O unit, problem box)

Volser Range: volser range assigned the compartments in a Coordinate Range

#### Overview

This function is used to reassign compartments.

In the archive catalog you can assign connected compartments (coordinate ranges) new volser ranges without changing the archive catalog entries of the remaining compartments (e. g. by reassigning empty compartments after ejecting the media previously stored in them).

The archive catalog is only restructured internally, but not created afresh.

**Edit Volser Ranges** changes

- the configuration and the archive catalog or
- only the archive catalog



#### ATTENTION!

**A correctly created archive catalog is the precondition for AMU operation. You are responsible to ensure that the archive catalog entries agree with the configuration.**

**Deliberate inconsistencies are possible and the user will be responsible for them. Before making changes check the consistency of archive catalog and configuration.**



#### ATTENTION!

**Changes to the database made with Edit Volser Range or with SQL commands are not procolled in the journal file of the database backup system. If the Restore command is used within 24 hours, the databse will be reset to the status before the changes were made.**

**The changed data records are immediately transferred to the backup or dual-AMU.**







#### Information



**Be sure to use the field Mask correctly to compute the coordinate range (👉 Page 4-28).**

### Window Edit Volser Ranges

Fig. 4-18: Window "Edit Volser Ranges"

Field	Explanation
<b>from Volser</b>	<p> <b>Information</b></p> <p>Always fill up the volser to 16 digits using fill-in characters (e. G. .....000001).</p> <p>First volser of the volser range.</p>
<b>to Volser</b>	<p> <b>Information</b></p> <p>Always fill up the volser to 16 digits using fill-in characters (e. G. .....000001).</p> <p>Last volser of the volser range (automatic).</p>
<b>Mask</b>	<ul style="list-style-type: none"> <li>• 9 - automatic count of the volser</li> <li>• A - symbol, not an automatic count of the volser</li> </ul>
<b>from Coord</b>	First archive coordinate of the coordinate range.
<b>to Coord</b>	Last archive coordinate of the coordinate range (automatic).

Field	Explanation
<b>Attribute</b>	Status of the medium <ul style="list-style-type: none"> <li>• Occupied: medium occupies compartment</li> <li>• Ejected: medium ejected</li> <li>• Empty: compartment is empty</li> <li>• Mounted: medium is mounted in a drive</li> </ul>
<b>Owner</b>	Medium owner: the robot or robots which can access this medium.
<b>Type</b>	Type of compartment <ul style="list-style-type: none"> <li>• <b>Storage</b>: archive compartment for hierarchically defined volser ranges</li> <li>• <b>Foreign</b>: foreign medium compartment</li> <li>• <b>Clean</b>: cleaning medium compartment</li> <li>• <b>HACC-Dynamic</b>: range exclusively for HACC/MVS</li> <li>• <b>AMU-Dynamic</b>: range for insert/eject of certain host software</li> <li>• <b>Problem</b>: compartment in the problem box (I/O unit)</li> </ul>
<b>Use Count</b>	Number of times the compartment has been accessed.
<b>Crash Count</b>	not used
<b>Find Volser Range</b>	Displays the remaining data when an existing volser or the archive coordinate of a volser range is entered.
<b>Delete Volser Range</b>	 <p><b>ATTENTION!</b></p> <p><b>Delete Volser Range deletes the entire volser range from the configuration.</b></p>
<b>Next</b>	Displays the next volser range.
<b>Wipe</b>	Deletes all input from the window.
<b>Update all</b>	Changes the archive catalog and the configuration. <p>  <p><b>ATTENTION!</b></p> <p><b>The existing archive catalog entries and the configuration are overwritten!</b></p> </p> <p>A list of all changes appears. The changes are executed after confirmation. A message appears after the execution (e. g. Database Update performed successfully!).</p>

Field	Explanation
<b>Update Database only</b>	<p>Changes the archive catalog.</p> <p> <b>ATTENTION!</b></p> <p><b>The existing archive catalog entries are overwritten!</b></p> <p><b>Inconsistencies between archive catalog and configuration are possible!</b></p> <p>A list of all changes appears. The changes are executed after confirmation. A message appears after the execution (e. g. Database Update performed successfully!).</p>
<b>Update E/I/F</b>	<p>Activate the changes in <b>Graphical Configuration</b> of <b>Logical Ranges</b> in the I/O unit in the database.</p> <p> <b>ATTENTION!</b></p> <p><b>First change the graphical configuration and restart the AMU (QVW S. 3-93).</b></p>

### Inserting a new volser range

- Enter the desired volser range
- Enter the next available archive coordinate. The end coordinate is inserted automatically
- Automatic entries for new volser ranges:
  - Attribute: **Occupied**
  - Owner: 1
  - Use Count: 0
  - Crash Count: 0
- Change the following
  - Volser
  - Mask
  - Owner
  - Type
- Click on **Update all**

### Changing an existing volser range

- Move the volser range to be changed into the window
  - either click on **Next**
  - or enter a volser/an archive coordinate and click on **Find Volser Range**
- Delete all input that is not to be changed
- Change the remaining input or enter changes
- Click on **Update all**

### Changing single archive catalog entries

- Click on **Wipe** to remove all input
- Define the archive catalog entry or entries with their
  - volser(s) or
  - archive coordinates
- Delete all input that is not to be changed
- Change the remaining input or enter changes
- Click on **Update Database only**



## 4.5 Adding a New User

---

- a) Change to the OS/2 desktop
- b) Open the “User Profile Management Services”
- c) Open “Logon” and log on as an administrator (AMUADMIN)
- d) Open the “User Profile Management”:



Fig. 4-19: Window User Profile Management - User Profile

- e) In the “Manage” menu select the command “Manage Users...”:



Fig. 4-20: Window User Profile Management - User Management

- f) In the “Actions” menu select the command “Add a new User ID...”

The screenshot shows a dialog box titled "Add a New User". It is divided into several sections. The top section, "Specify new user information", contains a "User ID" field with the text "AMUADMIN" and a "Comment" field with the text "AMU Administrator". Below this are two columns of radio buttons. The left column, "User Type", has options: "User", "Accounts Operator", "Local Administrator", and "Administrator" (which is selected). The right column, "Logon", has options: "Allowed" (selected) and "Denied". The bottom section, "Password Confirmation", has two text boxes: "Type password" and "twice". To the right of this is an "Options" section with radio buttons for "Password Required" (selected), "Expire Password", and "Password Optional". At the bottom of the dialog are three buttons: "OK", "Cancel", and "Help".

Fig. 4-21: Window Add a New User

- g) Define the new user:
- User ID: name of the new user
  - Comment: for additional information
  - User Type: "User"
  - Logon: "Allowed"
  - Password: required
  - Options: "Required"
- h) Confirm the input. The new user appears on the list of the "User Profile Management - User Profile"
- i) Close the windows
- "User Management"
  - "User Profile Management"
  - "User Profile Management Services"



### ATTENTION!

After a reinstallation of OS/2 no entries are in the User Profile Management.

Make following entries (user ID, password, user type):

- AMUUSER, AMUUSER, Administrator
- AMUADMIN, \*\*\*\*\*, Administrator

### 4.6 OS/2 Commands

---

#### 4.6.1 Saving Files

---

Regularly save the log and trace files.

AMU stores these in the directory `c:\amu\logs-trc`.

The log's filename (e. g. `log1904.001`) comprises

- `log`: log file
- `1904`: date (19th April)
- `.001`: count number

The trace's filename (e. g. `trce.001`) comprises

- `trce`: trace file
- `.001`: count number

- a) Change to an OS/2 window.
- b) Convert the file into an ASCII file (☞ Page 4-21).
- c) Compress files before copying them, if necessary (☞ Page 4-36).
- d) Copy the files with `copy Par1 Par2`
  - `Par1`: source file with path  
(e. g. `c:\amu\logs-trc\log*. *` or  
`c:\amu\logs-trc\trace. *`)
  - `Par2`: target directory (e. g. `a:`)

### 4.6.2 Compressing Files

---

You can compress files with the programs “pkzip” or “pkzip2” and reduce them to about half of their original size.

- a) Change to an OS/2 window.
- b) Change to the directory storing the file to be compressed.
- c) Enter `pkzip2 Par1 Par2`
  - Par1: name of compressed file (.zip is automatically added)
  - Par2: specification of files to be compressed (e. g. `log*.*`)
- d) Copy the compressed file onto a diskette.



#### Information

Enter `pkzip` or `pkzip2` without parameters to display information on these programs.

### 4.6.3 Decompressing Files

---

You can decompress files with the programs `pkunzip2` or `pkunzip` (depending on the OS/2 version).

- a) Change to an OS/2 window.
- b) Copy the compressed file into the directory in which you want to store the decompressed files.
- c) Change to that directory.
- d) Enter `pkunzip2 Par1`
  - Par1: name of the compressed file
- e) Delete the compressed file if necessary.



#### Information

Enter `pkunzip2` without parameters to display information on this program.

### 4.7 Disaster Recovery Support

---

Ejecting predefined media from the AML archive without HOST.

#### 4.7.1 Precondition

---

The file \*.DSR with the media to be ejected is stored in C:\AMU\RECOVERY.

#### 4.7.2 Preparing the Disaster Recovery Support

---

##### Create a file listing the media to be ejected

Create the file with any ASCII editor.  
Copy the file into the directory C:\AMU\RECOVERY.



##### Information

To create and edit the file you can also use the OS/2 Editor “E” on the AMU PC.

##### Structure of the file

- Put the Volsers of media at the beginning of the lines.
- For optical disks give only one of the two Volsers.
- A file contain only volser of one mediatype.
- Enter the Volsers without filling signs (.).
- At least one blank must follow the Volser.
- Any comment can follow the blank.
- Line length is limited to 80 characters.
- Close lines with CR/LF.

Example:

```
004711 recovery medium 1
004712 recovery medium 2
00123456789 recovery medium 3
...
000815 recovery medium n
```



### Information

**In AML/2 twin robot systems media in linear shelves or asymmetric storage towers cannot be gripped by both robots. Do not file media for Disaster Recovery in such areas.**

### 4.7.3 Ejecting Media for Disaster Recovery

---

- a) Unload all drives.
- b) Return the media unloaded to their home positions using the **KEEP** command.
- c) In the menu **Service** select the command **Disaster Recovery**.
- d) Enter the password (defined with **Process Configuration** (☞ Page 3-51)).
- e) Select the file to eject.
- f) Start the ejection with **Start**.
- g) Upon being prompted, unload all media from all I/O units.
- h) Confirm the ejection with **OK**.  
The media are ejected in the sequence indicated in the file.
- i) Unload the I/O unit when the prompt to do so appears on the operating console.
- j) Continue ejecting with **OK**.  
When the last medium has been ejected the command execution is confirmed.

# 5 Procedures

---

## 5.1 Switching the AMU Computer On

---

- a) Switch the alternating switch for monitor, mouse and keyboard to the computer you wish to switch on (only on systems with dual-AMU).
- b) Switch the ADS to AUTO (only on systems with dual-AMU).
- c) Switch the computer on
  - computer Bios initializes
  - operating system is loaded
  - command file `startup` is automatically processed (starts communication and AMU processes)
- d) Select the window „AMU V.“ by clicking on the headline of the window.
- e) Select the command **Log** from the **View** menu.
- f) Check the messages for errors during startup (☞ Problem Determination Guide).

### 5.2 Starting the AMU Operating Console

---



#### Information

Follow this start procedure for the AMU operating console only if it does not appear on the monitor anymore or if it has unintentionally been terminated:

- a) Press <CTRL> + <ESC> (process list).
- b) Check whether CON and KRN have been started.

#### Only „KRN.EXE“ has been started

- a) Change to an OS/2 input window.
- b) Enter the following commands in the OS/2 input window:  
[C:\]cd amu  
[C:\AMU]con

#### Only AMU has been started

- a) Change to an OS/2 input window.
- b) Enter the following commands in the OS/2 input window:  
[C:\]cd amu  
[C:\AMU]krn
- c) Press <CTRL> + <ESC> (process list) and change the AMU process.

#### None of the two processes has been started

- a) Change to an OS/2 input window.
- b) Enter the following commands in the OS/2 input window:  
[C:\]startup



### 5.3 Terminating the AMU Operating Console

---



#### ATTENTION!

Deviate from the following procedure for termination of the AML system only in case of emergency. Otherwise some files required for restart of the system may be altered or destroyed!

#### 5.3.1 Switching the AMU Computer Off

---



#### Information

The computer runs continuously and therefore is not controlled by the main switch of the AML system!



#### ATTENTION!

Possible loss of data or very long startup procedure.  
Switch the AMU computer off only as described here.

Before switching the AMU computer off:

- terminate the AMU operating console and OS/2 with **Shutdown AML with OS/2** or
- terminate the AMU operating console with **Shutdown AML...** and then perform a system shutdown (☞ Page 5-4).

### System shutdown for OS/2 version 2.1 or 3.0

- a) Change to the OS/2 desktop.
  - Open the task list with <CTRL> + <ESC>.
  - Select „Desktop Icon - View“.
- b) Call up the system menu.
  - If an icon is selected press <SPACE>.
  - Press <SHIFT> + <F10> or the right mouse button.



Abb. 5-1: System Menu OS/2

- c) Select **Shut down...** (system shutdown).
- d) Confirm the subsequent prompts.
- e) Wait for the message  
„Shutdown has completed. It is now safe to turn off your computer, or restart the system by pressing Ctrl+Alt+Del“.
- f) Switch the computer off only after the above message has appeared.

## 5.4 Remote Power ON/OFF

---

Due to the separate location of operating and AML system it will sometimes be necessary to perform a remote shutdown.

A complete shutdown of AMU (software), the operating system - and thereby orderly closing of the file system HPFS - is possible on AMU version 2.1 or higher with the host command „AOFF“.

The physical shutdown or power-up of the system can be controlled thereafter by automation products such as ATOP (Automatic Operator) or data control center installations requiring some minor changes in the electrical supply to the AML system.

### 5.5 Switching Over between the Dual-AMU Computers

---

#### Preconditions

- 2 AMU computers are installed and operating.
- Automatic Data Switch is installed and is set to AUTO (automatic).
- Both AMU computers are of identical configuration.
- The host software supports dual-AMU (currently only available for HACC/MVS and ROBAR).

#### Limitations

ROBAR must not send a ROSA command to the alternative AMU if HACC/MVS is used simultaneously. This would interrupt the communication with HACC/MVS.

### Switching over from dual-AMU(A) to dual-AMU(B)



#### ATTENTION!

**The switch-over affects all host systems connected. Inform all other host administrators involved, when switching over to the dual-AMU.**



#### Information

**The exact syntax of the host commands is found in the documentation of the respective host software.**

- a) Stop amu - host communication (e. g. with HACC/MVS command HOLD).
- b) Stop the robot if this is still possible (e. g. with HACC/MVS command ROSO). This stop command is acknowledged to all hosts connected.
- c) Switch communication over to the dual-AMU (e. g. HACC/MVS command SWITCH).
- d) Check the command queue for errors and current content (e. g. HACC/MVS command DRQ).
- e) Activate the dual-AMU with a ROSA command of your host software.
  - In the AMU addressed, the BUD switches from BUD-passive to BUD-active (with any subsequent command the AMU will try to send the database changes to a connected AMU).
  - A dual-AMU still running will receive the status command to switch over from BUD-active to BUD-passive.
  - The Automatic Data Switch receives the command to switch over the connection between AMU and robot controller.
  - AMU sends a status command to the robot controller.
  - An acknowledgement of the status command is sent to all hosts connected.
- f) Activate the connection of ROBAR to the alternative AMU with the command ROSA (in a multi-host environmen).
- g) Delete the commands no longer required from the command queue (e. g. with HACC/MVS command DELQ).
- h) Start the communication with AMU (e. g. with HACC/MVS command RELEASE).
- i) Repeat commands still needing to be executed (e. g. with HACC/MVS command REP).

# 6 Error Messages and Trouble Shooting

---

## 6.1 General Information

---

All messages, including the error messages, are displayed in the log window of the AMU operating console. The error number appears in brackets at the end of the message.

Additionally the host processor receives an error information.

You can call up additional information on the operating system level (in an OS/2 window).

Enter `help amu` and the error number.

If no solution is given or if you cannot otherwise resolve the error, inform the maintenance technician of your service partner or ADIC/GRAU Storage Systems.



### **CAUTION!**

**If you need to enter the archive to find or resolve an error, be sure to observe the safety rules (☞ MG chapter 3 „Safety“).**

### 6.2 Host Computer Error Codes

---

N001: syntax error

N002: unexpected response from robot

N003: serious error in setup-file

N004: serious error in archive mirror

N005: robot not ready

N006: robot error (see preceding warning)

N007: error situation cannot be diagnosed

N008: robot emergency stop

N009: robot switched into set-up mode

N010: unknown robot command

N011: invalid assignment (e. g. Robot-Volser)

N012: command interrupted by manual intervention

N014: command interrupted by program request

N015: tower has not turned into position

N016: robot error EXCP\_OUT 5001

N017: command cannot be executed

N100: unexpected robot crash

N101: robot crash at cartridge removal/replacement

N102: timeout robot

N103: timeout PC-IC communication

N104: cartridge lost

N105: cartridge stuck in gripper

N110: crash at taking a cartridge from a box

N111: crash at inserting a cartridge into a box

N112: crash at taking a cartridge from a tape drive

N113: crash at inserting a cartridge into a tape drive

## Host Computer Error Codes

---

- N201: unknown tape drive
- N202: device occupied (detected by AMU)
- N203: device empty (detected by AMU)
- N204: device occupied (detected by robot)
- N205: device empty (detected by robot)
- N206: cartridge cannot be removed from tape drive
- N207: device door cannot be closed
- N208: cartridge cannot be removed from tape drive (3490)
- N301: unknown volser
- N302: volser not in archive
- N304: barcode label not readable
- N305: no cartridge label detected/no cartridge found
- N306: wrong volser on specified coordinate
- N401: coordinate not defined
- N402: no cartridge on specified coordinate
- N403: coordinate slot should be empty but is occupied
- N501: door of an I/O-rack is not closed
- N502: I/O tower definitions do not agree
- N503: eject device compartment full
- N504: cartridge in cartridge box
- N505: problem box is full

### 6.3 AMU Error Messages and System Information

Robot system errors

When the errors 1 through 299 occur the robot is set to the “not ready” state by AMU. A subsequent host processor command is answered with “robot not ready” N005.

If AMU does not display error messages, the PHG may display the current errors: Mode 7.2 “Diagnosis Errors” (☞ MG 4.5.13 d) „Menu Tree of rho: PHG Operating System“).

#### 6.3.1 Robot Control System Errors

AMU	Host	AMU Error Message	Cause	Note	rho Error
0001	N006	"Controller runtime error [0001 - 0255]."	Robot control system runtime error without subsequent error.	Reset the robot control system to restart it.	error 1 - 255
0002	N006	"Controller runtime error (transformation error [0007])."	Transformation of coordinates in robot control system stopped due to a program error.	Reset robot control system to restart, inform ADIC/GRAU Storage Systems service department.	error 7 transformation error in IRDATA program
0003	N006	"Controller runtime error (IRD- or PKT-file is missing [0008])."	Files are missing in the robot control system.	List the files currently in the memory of the robot control system. Copy missing files into the control system. Reset the control system to restart it.	error 8 IRD- or PKT- file does not exist.
0004	N006	"Controller runtime error (negative wait time entry [0009])."	Variables error in the robot control program.	Reset the control system to restart, inform ADIC/GRAU Storage Systems service department.	error 9 negative wait time has been programd
0005	N006	"Controller runtime error (EXTENSION is not active [0017])."	Wrong rho3 machine parameters with inactive extensions of the control system.	Copy the backup of the machine parameters into the control system, reset the control system to restart it.	error 17 extension not active
0006	N006	"Controller runtime error (wrong format in DAT file [0028])."	Data type of the variable to be read does not agree with the format in the file.	Check all DAT files for wrong input of parameters. Reset the control system to restart it.	error 28 format error in DAT-file



## AMU Error Messages and System Information

AMU	Host	AMU Error Message	Cause	Note	rho Error
0007	N006	"Controller runtime error (error in transmission layer [0032])."	The value to be written into the robot control system is higher than the format allows.	Check the connecting cable.	error 32 protocol error during writing
0008	N006	"Controller runtime error (error in transmission layer [0033])."	The format read in the robot control system does not agree with the set format.	Check the connecting cables.	error 33 protocol error during reading
0009	N006	"Controller runtime error (process hung up [0040])."	Robot control system error in the program.	Reset the robot control system to restart it.	error 40 application processor
0010	N006	"Controller runtime error (memory error [0054])."	Application memory is full.	Delete files not required for the system from the memory and compress files in the memory by a reset.	error 54 application memory full.
0011	N006	"Controller runtime error (end of file error [0059])."	The number or read accesses in the program exceed the number of values in the file.	Check the DAT files for completeness.	error 59 During READ access the end of file was reached in the file EA.
0012	N006	"Controller runtime error (missing file error [0061])."	The selected file is not available or has a wrong name.	List the files currently in the memory of the robot control system. Copy missing files into the control system. Reset the control system to restart it.	error 61 file does not exist during READ or WRTIE
0013	N006	"Controller runtime error (data format error [0070])."	The data format of the DAT files in control system is not correct.	Check the DAT files.	error 70 error in data format
0014		"Controller runtime error (timecontrol interpolator-stop [0072])."		not used in AML	error 72
0015		"Controller runtime error (posiconcontrol error [0073])."		not used in AML	error 73
0016		"Controller runtime error (wrong number of kinematics [0010])."	The number of kinematics in the machine parameters does not agree with those defined in the TKONFIG.DAT (Quadro tower 0 or 1).	Check the TKONFIG.DAT and the machine parameters 1	error 10 number of kinematics in program and control system do not agree
0017 - 0018 reserved					
0019		"Controller runtime error [0001 - 0255]."	Robot control system run-time error without subsequent error.	Reset the robot control system to restart it.	error 1 - 255

## AMU Error Messages and System Information

AMU	Host	AMU Error Message	Cause	Note	rho Error
0020		"Controller CAN error (intermediate circuit axis 1 voltage higher 400 V [0272])."	Errors in the drive amplifier for axis 1 and the power supply board for the drive amplifiers, may be to fast switch-on/off (intermediate circuit voltage of the drive amplifier is too high).	Switch off the main switch and switch it back on after approx. 2 minutes. Check the fuse F1 of power supply 160. Possibly the ballast resistor or the power supply 160 is defective.	error 272 CAN ZWK voltage > 400 V axis 1
0021		"Controller CAN error (intermediate circuit axis 2 voltage higher 400 V [0273])."	Errors in the drive amplifier for axis 2 and the power supply board for the drive amplifiers (temperature >110 °C, intermediate circuit voltage >400 V or loss of phase for 100 ms, may be to fast switch-on/off ).	Switch off the main switch and switch it back on after approx. 2 minutes. Check the fuse F1 of power supply 160. Possibly the ballast resistor or the power supply 160 is defective.	error 273 CAN ZWK voltage > 400 V axis 2
0022		"Controller CAN error (intermediate circuit axis 3 voltage higher 400 V [0274])."	Errors in the drive amplifier for axis 3 and the power supply board for the drive amplifiers (temperature >110 °C, intermediate circuit voltage >400 V or loss of phase for 100 ms, may be to fast switch-on/off ).	Switch off the main switch and switch it back on after approx. 2 minutes. Check the fuse F1 of power supply 160. Possibly the ballast resistor or the power supply 160 is defective.	error 273 CAN ZWK voltage > 400 V axis 3
0023		"Controller CAN error (intermediate circuit axis 4 voltage higher 400 V [0275])."	Errors in the drive amplifier for axis 4 and the power supply board for the drive amplifiers (temperature >110 °C, intermediate circuit voltage >400 V or loss of phase for 100 ms, may be to fast switch-on/off ).	Switch off the main switch and switch it back on after approx. 2 minutes. Check the fuse F1 of power supply 160. Possibly the ballast resistor or the power supply 160 is defective.	error 275 CAN ZWK voltage > 400 V axis 4
0024		"Controller CAN error (intermediate circuit axis 5 voltage higher 400 V [0276])."	Errors in the drive amplifier for axis 5 and the power supply board for the drive amplifiers (temperature >110 °C, intermediate circuit voltage >400 V or loss of phase for 100 ms, may be to fast switch-on/off ).	Switch off the main switch and switch it back on after approx. 2 minutes. Check the fuse F1 of power supply 160. Possibly the ballast resistor or the power supply 160 is defective.	error 276 CAN ZWK voltage > 400 V axis 5

## AMU Error Messages and System Information

AMU	Host	AMU Error Message	Cause	Note	rho Error
0025		"Controller CAN error (intermediate circuit axis 6 voltage higher 400 V [0277])."	Errors in the drive amplifier for axis 6 and the power supply board for the drive amplifiers (temperature >110 °C, intermediate circuit voltage >400 V or loss of phase for 100 ms, may be to fast switch-on/off ).	Switch off the main switch and switch it back on after approx. 2 minutes. Check the fuse F1 of power supply 160. Possibly the ballast resistor or the power supply 160 is defective.	error 277 CAN ZWK voltage > 400 V axis 6
0026		"Controller CAN error (transistor temperature axis 1 too high [0288])."	Heat sink temperature of the power transistor in the drive amplifier for axis 1 <85 °C.	Check the control cabinet fans and the ambient temperature, if necessary replace the drive amplifier for axis 1. Restart by main switch off/on.	error 288 CAN transistor temperature axis 1
0027		"Controller CAN error (transistor temperature axis 2 too high [0289])."	Heat sink temperature of the power transistor in the drive amplifier for axis 2 <85 °C.	Check the control cabinet fans and the ambient temperature, if necessary replace the drive amplifier for axis 2. Restart by main switch off/on.	error 289 CAN transistor temperature axis 2
0028		"Controller CAN error (transistor temperature axis 3 too high [0290])."	Heat sink temperature of the power transistor in the drive amplifier for axis 3 <85 °C.	Check the control cabinet fans and the ambient temperature, if necessary replace the drive amplifier for axis 3. Restart by main switch off/on.	error 290 CAN transistor temperature axis 3
0029		"Controller CAN error (transistor temperature axis 4 too high [0291])."	Heat sink temperature of the power transistor in the drive amplifier for axis 4 <85 °C.	Check the control cabinet fans and the ambient temperature, if necessary replace the drive amplifier for axis 4. Restart by main switch off/on.	error 291 CAN transistor temperature axis 4
0030		"Controller CAN error (transistor temperature axis 5 too high [0292])."	Heat sink temperature of the power transistor in the drive amplifier for axis 5 <85 °C.	Check the control cabinet fans and the ambient temperature, if necessary replace the drive amplifier for axis 5. Restart by main switch off/on.	error 292 CAN transistor temperature axis 5
0031		"Controller CAN error (transistor temperature axis 6 too high [0293])."	Heat sink temperature of the power transistor in the drive amplifier for axis 6 <85 °C.	Check the control cabinet fans and the ambient temperature, if necessary replace the drive amplifier for axis 6. Restart by main switch off/on.	error 293 CAN transistor temperature axis 6
0032		"Controller CAN error (motor temperature axis 1 too high [0304])."	Motor on axis 1 overheated (>155 °C), mechanic overload of the motor due to hard movement, wrong drive amplifier parameters or motor defect.	Check for easy mechanic movement and check the drive amplifier parameters. Restart by main switch off/on.	error 304 CAN motor temperature axis 1

## AMU Error Messages and System Information

AMU	Host	AMU Error Message	Cause	Note	rho Error
0033		"Controller CAN error (motor temperature axis 2 too high [0305])."	Motor on axis 2 overheated (>155 °C), mechanic overload of the motor due to hard movement, wrong drive amplifier parameters or motor defect.	Check for easy mechanic movement and check the drive amplifier parameters. Restart by main switch off/on.	error 305 CAN motor temperature axis 2
0034		"Controller CAN error (motor temperature axis 3 too high [0306])."	Motor on axis 3 overheated (>155 °C), mechanic overload of the motor due to hard movement, wrong drive amplifier parameters or motor defect.	Check for easy mechanic movement and check the drive amplifier parameters. Restart by main switch off/on.	error 306 CAN motor temperature axis 3
0035		"Controller CAN error (motor temperature axis 4 too high [0307])."	Motor on axis 4 overheated (>155 °C), mechanic overload of the motor due to hard movement, wrong drive amplifier parameters or motor defect.	Check for easy mechanic movement and check the drive amplifier parameters. Restart by main switch off/on.	error 307 CAN motor temperature axis 4
0036		"Controller CAN error (motor temperature axis 5 too high [0308])."	Motor on axis 5 overheated (>155 °C), mechanic overload of the motor due to hard movement, wrong drive amplifier parameters or motor defect.	Check for easy mechanic movement and check the drive amplifier parameters. Restart by main switch off/on.	error 308 CAN motor temperature axis 5
0037		"Controller CAN error (motor temperature axis 6 too high [0309])."	Motor on axis 6 overheated (>155 °C), mechanic overload of the motor due to hard movement, wrong drive amplifier parameters or motor defect.	Check for easy mechanic movement and check the drive amplifier parameters. Restart by main switch off/on.	error 309 CAN motor temperature axis 6
0038 reserved					
0039		"Controller CAN error (CAN Logicpower 5V/15V missing [0256 - 0267])."	The logic voltage is not generated correctly in the power supply 160.	Replace the power supply 160.	error 256 - 267 CAN logic voltage 5V/15V axes 1 - 12
0040 reserved					
0041		"Controller CAN error (intermediate circuit voltage higher 400 V [0272 - 0283])."	Errors in the drive amplifiers and the power supply board for the drive amplifiers (temperature >110 °C, intermediate circuit voltage >400 V or loss of phase for 100 ms, may be to fast switch-on/off ).	Switch off the main switch and switch it back on after approx. 2 minutes. Check the fuse F1 of power supply 160. Possibly the ballast resistor or the power supply 160 is defective.	error 272 - 283 CAN ZWK voltage > 400 V axes 1 - 12

## AMU Error Messages and System Information

AMU	Host	AMU Error Message	Cause	Note	rho Error
0042		"Controller CAN error (transistor temperature too high [0288 - 0299])."	Heat sink temperature of the power transistor in the drive amplifier <85 °C.	Check the control cabinet fans and the ambient temperature. Restart by main switch off/on.	error 288 - 299 CAN transistor temperature axes 1 - 12
0043		"Controller CAN error (motor temperature too high [0304 - 0315])."	Motor overheated, mechanic overload of the motor due to hard movement, wrong drive amplifier parameters or motor defect.	Check for easy mechanic movement and check the drive amplifier parameters. Restart by main switch off/on.	error 304 - 315 CAN motor temperature axes 1 - 12
0044 - 0050 reserved					
0051		"Controller CAN error (resolvererror axis 1 [0320])."	Connection drive amplifier - position measuring system (Resolver) axis 1 faulty.	Check the resolver cable, if necessary replace the motor.	error 320 CAN resolver error axis 1.
0052		"Controller CAN error (resolvererror axis 2 [0321])."	Connection drive amplifier - position measuring system (Resolver) axis 2 faulty.	Check the resolver cable, if necessary replace the motor.	error 321 CAN resolver error axis 2.
0053		"Controller CAN error (resolvererror axis 3 [0322])."	Connection drive amplifier - position measuring system (Resolver) axis 3 faulty.	Check the resolver cable, if necessary replace the motor.	error 322 CAN resolver error axis 3.
0054		"Controller CAN error (resolvererror axis 4 [0323])."	Connection drive amplifier - position measuring system (Resolver) axis 4 faulty.	Check the resolver cable, if necessary replace the motor.	error 323 CAN resolver error axis 4.
0055		"Controller CAN error (resolvererror axis 5 [0324])."	Connection drive amplifier - position measuring system (Resolver) axis 5 faulty.	Check the resolver cable, if necessary replace the motor.	error 324 CAN resolver error axis 5.
0056		"Controller CAN error (resolvererror axis 6 [0325])."	Connection drive amplifier - position measuring system (Resolver) axis 6 faulty.	Check the resolver cable, if necessary replace the motor.	error 325 CAN resolver error axis 6.
0057		"Controller CAN error (resolver error [0320 - 0331])."	Connection drive amplifier - position measuring system (Resolver) faulty.	Check the resolver cable, if necessary replace the motor.	error 320 - 331 CAN resolver error axes 1 - 12.
0058		"Controller CAN error (CAN parameter error axis 1 [0336])."	Initialization error or RAM defective in drive amplifier (wrong checksum).	Replace drive amplifier, inform ADIC/GRAU Storage Systems service department.	error 336 CAN parameter error axis 1
0059		"Controller CAN error (CAN parametererror axis 2 [0337])."	Initialization error or RAM defective in drive amplifier (wrong checksum).	Replace drive amplifier, inform ADIC/GRAU Storage Systems service department.	error 337 CAN parameter error axis 2
0060		"Controller CAN error (CAN parametererror axis 3 [0338])."	Initialization error or RAM defective in drive amplifier (wrong checksum).	Replace drive amplifier, inform ADIC/GRAU Storage Systems service department.	error 338 CAN parameter error axis 3

## AMU Error Messages and System Information

AMU	Host	AMU Error Message	Cause	Note	rho Error
0061		"Controller CAN error (CAN parametererror axis 4 [0339])."	Initialization error or RAM defective in drive amplifier (wrong checksum).	Replace drive amplifier, inform ADIC/GRAU Storage Systems service department.	error 337 CAN parameter error axis 4
0062		"Controller CAN error (CAN parametererror axis 5 [0340])."	Initialization error or RAM defective in drive amplifier (wrong checksum).	Replace drive amplifier, inform ADIC/GRAU Storage Systems service department	error 340 CAN parameter error axis 5
0063		"Controller CAN error (CAN parametererror axis 6 [0341])."	Initialization error or RAM defective in drive amplifier (wrong checksum).	Replace drive amplifier, inform ADIC/GRAU Storage Systems service department.	error 341 CAN parameter error axis 6
0064		"Controller CAN error (CAN parametererror [0336 - 0347])."	Initialization error or RAM defective in drive amplifier (wrong checksum).	Replace drive amplifier, inform ADIC/GRAU Storage Systems service department.	error 336 - 347 CAN parameter error axis 1 - 12
0065		"Controller CAN error (temperature warning axis 1 [0352])."	Temperature of amplifier > 70° or of motor > 130 °C. The drive amplifiers output a warning.	Check the fans, filter mats and the ambient temperature.	error 352 CAN temperature warning axis 1
0066		"Controller CAN error (temperature warning axis 2 [0353])."	Temperature of amplifier > 70° or of motor > 130 °C. The drive amplifiers output a warning.	Check the fans, filter mats and the ambient temperature.	error 353 CAN temperature warning axis 2
0067		"Controller CAN error (temperature warning axis 3 [0354])."	Temperature of amplifier > 70° or of motor > 130 °C. The drive amplifiers output a warning.	Check the fans, filter mats and the ambient temperature.	error 354 CAN temperature warning axis 3
0068		"Controller CAN error (temperature warning axis 4 [0355])."	Temperature of amplifier > 70° or of motor > 130 °C. The drive amplifiers output a warning.	Check the fans, filter mats and the ambient temperature.	error 355 CAN temperature warning axis 4
0069		"Controller CAN error (temperature warning axis 5 [0356])."	Temperature of amplifier > 70° or of motor > 130 °C. The drive amplifiers output a warning.	Check the fans, filter mats and the ambient temperature.	error 356 CAN temperature warning axis 5
0070		"Controller CAN error (temperature warning axis 6 [0357])."	Temperature of amplifier > 70° or of motor > 130 °C. The drive amplifiers output a warning.	Check the fans, filter mats and the ambient temperature.	error 357 CAN temperature warning axis 6
0071		"Controller CAN error (temperature warning [0352 - 0363])."	Temperature of amplifier > 70° or of motor > 130 °C. The drive amplifiers output a warning.	Check the fans, filter mats and the ambient temperature.	error 352 - 363 CAN temperature warning axes 1 - 12

## AMU Error Messages and System Information

AMU	Host	AMU Error Message	Cause	Note	rho Error
0072		"Controller CAN error (CAN short circuit [0368 - 0379])."	Hardware error, connection to the motor, MCO module connected wrongly, or drive amplifier defective (current sensor of one of the three phase signals a short-circuit).	Check the connecting cable, MCO module, if necessary replace the amplifier board.	error 368 - 379 CAN short circuit error axes 1 - 12
0073		"Controller CAN error (no sync. byte [0384 - 0395])."	Initialization telegram for communication not received by robot control system, amplifier board or connecting cable defective. Control system - drive amplifier.	Check the connecting cable, if necessary replace the amplifier board.	error 384 - 395 CAN no sync. byte for axes 1 - 12
0074		"Controller CAN error (interpolator stop axis 1 [0400])."	Mechanics move hard, crash or problems with the motor control (motor cable).	Check the mechanics, if necessary replace motor cable, axis amplifier or motor.	error 400 CAN interpolator stop axis 1
0075		"Controller CAN error (interpolator stop axis 2 [0401])."	Mechanics move hard, crash or problems with the motor control (motor cable).	Check the mechanics, if necessary replace motor cable, axis amplifier or motor.	error 401 CAN interpolator stop axis 2
0076		"Controller CAN error (interpolator stop axis 3 [0402])."	Mechanics move hard, crash or problems with the motor control (motor cable).	Check the mechanics, if necessary replace motor cable, axis amplifier or motor.	error 402 CAN interpolator stop axis 3
0077		"Controller CAN error (interpolator stop axis 4 [0403])."	Mechanics move hard, crash or problems with the motor control (motor cable).	Check the mechanics, if necessary replace motor cable, axis amplifier or motor.	error 403 CAN interpolator stop axis 4
0078		"Controller CAN error (interpolator stop axis 5 [0404])."	Mechanics move hard, crash or problems with the motor control (motor cable).	Check the mechanics, if necessary replace motor cable, axis amplifier or motor.	error 404 CAN interpolator stop axis 5
0079		"Controller CAN error (interpolator stop axis 6 [0405])."	Mechanics move hard, crash or problems with the motor control (motor cable).	Check the mechanics, if necessary replace motor cable, axis amplifier or motor.	error 405 CAN interpolator stop axis 6
0080		"Controller CAN error (interpolator stop [0400 - 0411])."	Mechanics move hard, crash or problems with the motor control (motor cable).	Check the mechanics, if necessary replace motor cable, axis amplifier or motor.	error 400 - 411 CAN interpolator stop axes 1 - 12
0081		"Controller CAN error (no must value [0416 - 0427])."	Communication error between control system and drive amplifier.	Check the connecting cable, if necessary replace the amplifier board.	error 416 - 427 CAN no setpoint for axes 1 - 12
0082		"Controller CAN error (no is value [0432 - 0443])."	Communication error between control system and drive amplifier.	Check the connecting cable, if necessary replace the amplifier board.	error 432 - 443 CAN no actual value for axes 1 - 12
0083		"Controller CAN error (motion limit axis 1 [0448])."	Software limit switch of drive amplifier reached.	Check amplifier parameters and software version (EPROM).	error 448 CAN position limit axis 1

## AMU Error Messages and System Information

AMU	Host	AMU Error Message	Cause	Note	rho Error
0084		"Controller CAN error (motion limit axis 2 [0449])."	Software limit switch of drive amplifier reached.	Check amplifier parameters and software version (EPROM).	error 449 CAN position limit axis 2
0085		"Controller CAN error (motion limit axis 3 [0450])."	Software limit switch of drive amplifier reached.	Check amplifier parameters and software version (EPROM).	error 450 CAN position limit axis 3
0086		"Controller CAN error (motion limit axis 4 [0451])."	Software limit switch of drive amplifier reached.	Check amplifier parameters and software version (EPROM).	error 451 CAN position limit axis
0087		"Controller CAN error (motion limit axis 5 [0452])."	Software limit switch of drive amplifier reached.	Check amplifier parameters and software version (EPROM).	error 452 CAN position limit axis 5
0088		"Controller CAN error (motion limit axis 6 [0453])."	Software limit switch of drive amplifier reached.	Check amplifier parameters and software version (EPROM).	error 453 CAN position limit axis 6
0089		"Controller CAN error (motion limit [0448 - 0459])."	Software limit switch of drive amplifier reached.	Check amplifier parameters and software version (EPROM).	error 448 - 459 CAN position limit axes 1 - 12
0090		"Controller CAN error (motion offset axis 1 [0464])."	Mechanics move hard, crash or problems with the motor control (axis does not reach the target position).	Check the mechanics and the drive amplifier parameters, replace the axis amplifier or motor if necessary.	error 464 CAN motion offset error axis 1
0091		"Controller CAN error (motion offset axis 2 [0465])."	Mechanics move hard, crash or problems with the motor control (axis does not reach the target position).	Check the mechanics and the drive amplifier parameters, replace the axis amplifier or motor if necessary.	error 465 CAN motion offset error axis 2
0092		"Controller CAN error (motion offset axis 3 [0466])."	Mechanics move hard, crash or problems with the motor control (axis does not reach the target position).	Check the mechanics and the drive amplifier parameters, replace the axis amplifier or motor if necessary.	error 466 CAN motion offset error axis 3
0093		"Controller CAN error (motion offset axis 4 [0467])."	Mechanics move hard, crash or problems with the motor control (axis does not reach the target position).	Check the mechanics and the drive amplifier parameters, replace the axis amplifier or motor if necessary.	error 467 CAN motion offset error axis 4
0094		"Controller CAN error (motion offset axis 5 [0468])."	Mechanics move hard, crash or problems with the motor control (axis does not reach the target position).	Check the mechanics and the drive amplifier parameters, replace the axis amplifier or motor if necessary.	error 468 CAN motion offset error axis 5
0095		"Controller CAN error (motion offset axis 6 [0469])."	Mechanics move hard, crash or problems with the motor control (axis does not reach the target position).	Check the mechanics and the drive amplifier parameters, replace the axis amplifier or motor if necessary.	error 469 CAN motion offset error axis 6



## AMU Error Messages and System Information

AMU	Host	AMU Error Message	Cause	Note	rho Error
0096		"Controller CAN error (motion offset [0464 - 0475])."	Mechanics move hard, crash or problems with the motor control (axis does not reach the target position).	Check the mechanics and the drive amplifier parameters, replace the axis amplifier or motor if necessary.	error 464 - 475 CAN motion offset error axes 1 - 12
0097		"Controller CAN error (global CAN error [0496 - 0507])."	Drive amplifiers have been shut down due to an error, the error is specified by other messages.	Check further CAN error messages in the log file or in the control system.	error 496 - 507 global CAN error axis 1 - 12
0098 reserved					
0099		"Controller CAN error [0256 - 0511]."	General combined error message for errors on the drive amplifiers.	Restart by main switch off/on.	error 256 - 511 group 1 CAN error
0100 - 0101 reserved					
0102		"Controller measuring system error (emergency stop [0528])."	Signal E 0.5 on AML/2 and AML/E is not present in the rho control. Emergency stop circuit has been cut or <Control off> has been pressed.	Check the emergency stop circuit, switch on the control system., input board may be defective.	error 528 emergency stop input
0103		"Controller measuring system error (CAN alarm axis 1 [0512])."	Communication error control system - amplifiers.	Check the parameters in the drive amplifiers (cycle time), check the connecting cable, if necessary replace the amplifier board.	error 512 general CAN error CAN alarm axis 1
0104		"Controller measuring system error (CAN alarm axis 2 [0513])."	Communication error control system - amplifiers.	Check the parameters in the drive amplifiers (cycle time), check the connecting cable, if necessary replace the amplifier board.	error 513 general CAN error CAN alarm axis 2
0105		"Controller measuring system error (CAN alarm axis 3 [0514])."	Communication error control system - amplifiers.	Check the parameters in the drive amplifiers (cycle time), check the connecting cable, if necessary replace the amplifier board.	error 514 general CAN error CAN alarm axis 3
0106		"Controller measuring system error (CAN alarm axis 4 [0515])."	Communication error control system - amplifiers.	Check the parameters in the drive amplifiers (cycle time), check the connecting cable, if necessary replace the amplifier board.	error 515 general CAN error CAN alarm axis 4

## AMU Error Messages and System Information

AMU	Host	AMU Error Message	Cause	Note	rho Error
0107		"Controller measuring system error (CAN alarm axis 5 [0516])."	Communication error control system - amplifiers.	Check the parameters in the drive amplifiers (cycle time), check the connecting cable, if necessary replace the amplifier board.	error 516 general CAN error CAN alarm axis 5
0108		"Controller measuring system error (CAN alarm axis 6 [0517])."	Communication error control system - amplifiers.	Check the parameters in the drive amplifiers (cycle time), check the connecting cable, if necessary replace the amplifier board.	error 517 general CAN error CAN alarm axis 6
0109		"Controller measuring system error (CAN alarm [0512 - 0523])."	Communication error control system - amplifiers.	Check the parameters in the drive amplifiers (cycle time), check the connecting cable, if necessary replace the amplifier board.	error 512 - 523 general CAN error CAN alarm axes 1 - 12
0110 - 0112 reserved					
0113		"Controller measuring system error ([0512 - 0767])."	General combined error message for errors of the processor and the measuring system with band synchronization.	Restart by pressing reset on the PS 75 board.	error 512 - 599 group 2 P2 error, measuring system error
0114		"Controller measuring system error (speed overrun axis 1 [0600])."	Speed limit for axis 1 exceeded due to an error in the control system.	Restart by pressing reset on the PS 75 board. Inform ADIC/GRAU Storage Systems service department.	error 600 max. axis speed exceeded axis 1
0115		"Controller measuring system error (speed overrun axis 2 [0601])."	Speed limit for axis 2 exceeded due to an error in the control system.	Restart by pressing reset on the PS 75 board. Inform ADIC/GRAU Storage Systems service department.	error 601 max. axis speed exceeded axis 2
0116		"Controller measuring system error (speed overrun axis 3 [0602])."	Speed limit for axis 3 exceeded due to an error in the control system.	Restart by pressing reset on the PS 75 board. Inform ADIC/GRAU Storage Systems service department.	error 602 max. axis speed exceeded axis 3
0117		"Controller measuring system error (speed overrun axis 4 [0603])."	Speed limit for axis 4 exceeded due to an error in the control system.	Restart by pressing reset on the PS 75 board. Inform ADIC/GRAU Storage Systems service department.	error 603 max. axis speed exceeded axis 4
0118		"Controller measuring system error (speed overrun axis 5 [0604])."	Speed limit for axis 5 exceeded due to an error in the control system.	Restart by pressing reset on the PS 75 board. Inform ADIC/GRAU Storage Systems service department.	error 604 max. axis speed exceeded axis 5
0119		"Controller measuring system error (speed overrun axis 6 [0605])."	Speed limit for axis 6 exceeded due to an error in the control system.	Restart by pressing reset on the PS 75 board. Inform ADIC/GRAU Storage Systems service department.	error 605 max. axis speed exceeded axis 6
0120 - 0121 reserved					

## AMU Error Messages and System Information

AMU	Host	AMU Error Message	Cause	Note	rho Error
0122		"Controller measuring system error (speed overrun [0600 - 0619])."	Speed limit exceeded due to an error in the control system.	Restart by pressing reset on the PS 75 board. Inform ADIC/GRAU Storage Systems service department.	error 600-619 max. axis speed exceeded axes 1 - 20
0123		"Controller measuring system error (driving range overrun axis 1 [0624])."	Software limit switch reached, error in machine parameters or robot control program.	Check the machine parameters 202 - 205 and the teach values in the graphical configuration.	error 624 driving range reached on axis 1
0124		"Controller measuring system error (driving range overrun axis 2 [0625])."	Software limit switch reached, error in machine parameters or robot control program.	Check the machine parameters 202 - 205 and the teach values in the graphical configuration.	error 625 driving range reached on axis 2
0125		"Controller measuring system error (driving range overrun axis 3 [0626])."	Software limit switch reached, error in machine parameters or robot control program.	Check the machine parameters 202 - 205 and the teach values in the graphical configuration.	error 626 driving range reached on axis 3
0126		"Controller measuring system error (driving range overrun axis 4 [0627])."	Software limit switch reached, error in machine parameters or robot control program.	Check the machine parameters 202 - 205 and the teach values in the graphical configuration.	error 627 driving range reached on axis 4
0127		"Controller measuring system error (driving range overrun axis 5 [0628])."	Software limit switch reached, error in machine parameters or robot control program.	Check the machine parameters 202 - 205 and the teach values in the graphical configuration.	error 628 driving range reached on axis 5
0128		"Controller measuring system error (driving range overrun axis 6 [0629])."	Software limit switch reached, error in machine parameters or robot control program.	Check the machine parameters 202 - 205 and the teach values in the graphical configuration.	error 629 driving range reached on axis 6
0129		"Controller measuring system error (driving range overrun [0624 - 0643])."	Software limit switch reached, error in machine parameters or robot control program.	Check the machine parameters 202 - 205 and the teach values in the graphical configuration.	error 624-643 driving range reached on axes 1 - 6
0130 -0131 reservedr					
0132		"Controller measuring system error (endswitch axis 1 [0648])."	Software limit switch reached, error in machine parameters or robot control program.	Check the machine parameters 202 - 205 and the teach values in the graphical configuration.	error 648 driving range reached on axis 1
0133		"Controller measuring system error (endswitch axis 2 [0649])."	Software limit switch reached, error in machine parameters or robot control program.	Check the machine parameters 202 - 205 and the teach values in the graphical configuration.	error 649 driving range reached on axis 2
0134		"Controller measuring system error (endswitch axis 3 [0650])."	Software limit switch reached, error in machine parameters or robot control program.	Check the machine parameters 202 - 205 and the teach values in the graphical configuration.	error 650 driving range reached on axis 3

## AMU Error Messages and System Information

AMU	Host	AMU Error Message	Cause	Note	rho Error
0135		"Controller measuring system error (endswitch axis 4 [0651])."	Software limit switch reached, error in machine parameters or robot control program.	Check the machine parameters 202 - 205 and the teach values in the graphical configuration.	error 651 driving range reached on axis 4
0136		"Controller measuring system error (endswitch axis 5 [0652])."	Software limit switch reached, error in machine parameters or robot control program.	Check the machine parameters 202 - 205 and the teach values in the graphical configuration.	error 652 driving range reached on axis 5
0137		"Controller measuring system error (endswitch axis 6 [0653])."	Software limit switch reached, error in machine parameters or robot control program.	Check the machine parameters 202 - 205 and the teach values in the graphical configuration.	error 653 driving range reached on axis 6
0138		"Controller measuring system error (endswitch [0648 - 0667])."	Software limit switch reached, error in machine parameters or robot control program.	Check the machine parameters 202 - 205 and the teach values in the graphical configuration.	error 648-667 driving range reached on axes 1 - 20
0139		"Controller measuring system error ([0512 - 0767])."	General combined error message for errors of the processor and the measuring system.	Restart by pressing reset on the PS 75 board. Inform ADIC/GRAU Storage Systems service department.	error 668 - 719 group 2 P2 error, measuring system error
0140		"Controller measuring system error (measuring system alert axis 1 [0720])."		Measuring system not used on AML.	error 720 measuring system alarm axis 1
0141		"Controller measuring system error (measuring system alert axis 2 [0721])."		Measuring system not used on AML.	error 721 measuring system alarm axis 2
0142		"Controller measuring system error (measuring system alert axis 3 [0722])."		Measuring system not used on AML.	error 722 measuring system alarm axis 3
0143		"Controller measuring system error (measuring system alert axis 4 [0723])."		Measuring system not used on AML.	error 723 measuring system alarm axis 4
0144		"Controller measuring system error (measuring system alert axis 5 [0724])."		Measuring system not used on AML.	error 724 measuring system alarm axis 5
0145		"Controller measuring system error (measuring system alert axis 6 [0725])."		Measuring system not used on AML.	error 725 measuring system alarm axis 6
0146		"Controller measuring system error (measuring system alert [0720 - 0739])."		Measuring system not used on AML.	error 720-739 measuring system alarm axes 1 - 20

## AMU Error Messages and System Information

AMU	Host	AMU Error Message	Cause	Note	rho Error
0147		"Controller measuring system error ([0512 - 0767])."	General combined error message for errors of the processor and the measuring system.	Restart by pressing reset on the PS 75 board.	error 739 - 767 group 2 P2 error, measuring system error
0148		"Controller servo / inpos error (axisprocessor stopped servocard 1 [0768])."		Axis board type not used on AML.	error 768 axis processor standstill servo board 1
0149		"Controller servo / inpos error (axisprocessor stopped servocard 2 [0769])."		Axis board type not used on AML.	error 769 axis processor standstill servo board 2
0150 - 0151 reserved					
0152		"Controller servo / inpos error (servo error axis 1 [0776])."	Mechanics move hard, crash or problems with the motor control (motor cable) (rated offset exceeded by 30%).	Check the mechanics, if necessary replace motor cable, axis amplifier or motor.	error 776 servo error axis 1
0153		"Controller servo / inpos error (servo error axis 2 [0777])."	Mechanics move hard, crash or problems with the motor control (motor cable) (rated offset exceeded by 30%).	Check the mechanics, if necessary replace motor cable, axis amplifier or motor.	error 777 servo error axis 2
0154		"Controller servo / inpos error (servo error axis 3 [0778])."	Mechanics move hard, crash or problems with the motor control (motor cable) (rated offset exceeded by 30%).	Check the mechanics, if necessary replace motor cable, axis amplifier or motor.	error 778 servo error axis 3
0155		"Controller servo / inpos error (servo error axis 4 [0779])."	Mechanics move hard, crash or problems with the motor control (motor cable) (rated offset exceeded by 30%).	Check the mechanics, if necessary replace motor cable, axis amplifier or motor.	error 779 servo error axis 4
0156		"Controller servo / inpos error (servo error axis 5 [0780])."	Mechanics move hard, crash or problems with the motor control (motor cable) (rated offset exceeded by 30%).	Check the mechanics, if necessary replace motor cable, axis amplifier or motor.	error 780 servo error axis 5
0157		"Controller servo / inpos error (servo error axis 6 [0781])."	Mechanics move hard, crash or problems with the motor control (motor cable) (rated offset exceeded by 30%).	Check the mechanics, if necessary replace motor cable, axis amplifier or motor.	error 781 servo error axis 6
0158		"Controller servo / inpos error (servo error [0776 - 0795])."	Mechanics move hard, crash or problems with the motor control (motor cable) (rated offset exceeded by 30%).	Check the mechanics, if necessary replace motor cable, axis amplifier or motor.	error 776-795 servo error axes 1 - 20

## AMU Error Messages and System Information

AMU	Host	AMU Error Message	Cause	Note	rho Error
0159		"Controller servo / inpos error (interpolator stop error axis 1 [0800])."	Mechanics move hard, crash or problems with the motor control (motor cable).	Check the mechanics, if necessary replace motor cable, axis amplifier or motor.	error 800 interpolator-stop error axis 1
0160		"Controller servo / inpos error (interpolator stop error axis 2 [0801])."	Mechanics move hard, crash or problems with the motor control (motor cable).	Check the mechanics, if necessary replace motor cable, axis amplifier or motor.	error 801 interpolator-stop error axis 2
0161		"Controller servo / inpos error (interpolator stop error axis 3 [0802])."	Mechanics move hard, crash or problems with the motor control (motor cable).	Check the mechanics, if necessary replace motor cable, axis amplifier or motor.	error 802 interpolator-stop error axis 3
0162		"Controller servo / inpos error (interpolator stop error axis 4 [0803])."	Mechanics move hard, crash or problems with the motor control (motor cable).	Check the mechanics, if necessary replace motor cable, axis amplifier or motor.	error 803 interpolator-stop error axis 4
0163		"Controller servo / inpos error (interpolator stop error axis 5 [0804])."	Mechanics move hard, crash or problems with the motor control (motor cable).	Check the mechanics, if necessary replace motor cable, axis amplifier or motor.	error 804 interpolator-stop error axis 5
0164		"Controller servo / inpos error (interpolator stop error axis 6 [0805])."	Mechanics move hard, crash or problems with the motor control (motor cable).	Check the mechanics, if necessary replace motor cable, axis amplifier or motor.	error 805 interpolator-stop error axis 6
0165		"Controller servo / inpos error (interpolator stop error [0800 - 0819])."	Mechanics move hard, crash or problems with the motor control (motor cable).	Check the mechanics, if necessary replace motor cable, axis amplifier or motor.	error 800-819 interpolator-stop error axes 1 - 20
0166		"Controller servo / inpos error (not inpos error axis 1 [0824])."	Error during standstill monitoring, may be due to mechanic hard movement or crash.	Check mechanics, restart by pressing reset on PS 75 board.	error 824 not inpos error axis 1
0167		"Controller servo / inpos error (not inpos error axis 2 [0825])."	Error during standstill monitoring, may be due to mechanic hard movement or crash.	Check mechanics, restart by pressing reset on PS 75 board.	error 825 not inpos error axis 2
0168		"Controller servo / inpos error (not inpos error axis 3 [0826])."	Error during standstill monitoring, may be due to mechanic hard movement or crash.	Check mechanics, restart by pressing reset on PS 75 board.	error 826 not inpos error axis 3
0169		"Controller servo / inpos error (not inpos error axis 4 [0827])."	Error during standstill monitoring, may be due to mechanic hard movement or crash.	Check mechanics, restart by pressing reset on PS 75 board.	error 827 not inpos error axis 4
0170		"Controller servo / inpos error (not inpos error axis 5 [0828])."	Error during standstill monitoring, may be due to mechanic hard movement or crash.	Check mechanics, restart by pressing reset on PS 75 board.	error 828 not inpos error axis 5

## AMU Error Messages and System Information

AMU	Host	AMU Error Message	Cause	Note	rho Error
0171		"Controller servo / inpos error (not inpos error axis 6 [0829])."	Error during standstill monitoring, may be due to mechanic hard movement or crash.	Check mechanics, restart by pressing reset on PS 75 board.	error 829 not inpos error axis 6
0172		"Controller servo / inpos error (not inpos error [0824 - 0843])."	Error during standstill monitoring, may be due to mechanic hard movement or crash.	Check mechanics, restart by pressing reset on PS 75 board.	error 824-843 not inpos error axes 1 -20
0173		"Controller servo / inpos error (power on release is missing [0848 - 0867])."	Software error in the robot control system.	Restart by pressing reset on PS 75 board, inform ADIC/GRAU Storage Systems service department.	error 848-867 power on release is missing axis 1 - 20
0174		"Controller servo / inpos error (movement release is missing [0872 - 0891])."	Software error in the robot control system.	Restart by pressing reset on PS 75 board, inform ADIC/GRAU Storage Systems service department.	error 872-891 movement release is missing axes 1 - 20
0175		"Controller servo / inpos error (power on not allowed [0896 - 0919])."	Software error in the robot control system.	Restart by pressing reset on PS 75 board, inform ADIC/GRAU Storage Systems service department.	error 896-919 power on not allowed axes 1 - 20
0176		"Controller servo / inpos error (power servocard failure [0920])."		not used on AML	error 920 power on servo board is missing
0177		"Controller servo / inpos error ([0768 - 1023])."	Combined error message drive control monitoring.	Restart by pressing reset on PS 75 board, inform ADIC/GRAU Storage Systems service department.	error 0768 - 1023 group 3 servo error, inpos error
0178		"Controller generell error (missing power for input/output cards [1024])."	External power on NC-SPS-I/O board missing.	Check the 24 V connection on the NC-SPS-I/O board.	error 1024 power on I/O board(s) missing (64E/40A)
0179 - 0183 reserved					
0184		"Controller generell error ([1024 - 1279])."	General combined error message for the robot control system.	Restart by pressing reset on PS 75 board.	error 1024 - 1279 group 4: other errors
0185		"Controller generell warning (interpolator stop warning axis 1 [1280])."	Mechanics move hard, crash or problems with the motor control (motor cable) (rated offset exceeded by 10.5%).	Check the mechanics, if necessary replace motor cable, axis amplifier or motor.	error 1280 interpolator-stop warning axis 1
0186		"Controller generell warning (interpolator stop warning axis 2 [1281])."	Mechanics move hard, crash or problems with the motor control (motor cable) (rated offset exceeded by 10.5%).	Check the mechanics, if necessary replace motor cable, axis amplifier or motor.	error 1281 interpolator-stop warning axis 2

## AMU Error Messages and System Information

AMU	Host	AMU Error Message	Cause	Note	rho Error
0187		"Controller generell warning (interpolator stop warning axis 3 [1282])."	Mechanics move hard, crash or problems with the motor control (motor cable) (rated offset exceeded by 10.5%).	Check the mechanics, if necessary replace motor cable, axis amplifier or motor.	error 1282 interpolator-stop warning axis 3
0188		"Controller generell warning (interpolator stop warning axis 4 [1283])."	Mechanics move hard, crash or problems with the motor control (motor cable) (rated offset exceeded by 10.5%).	Check the mechanics, if necessary replace motor cable, axis amplifier or motor.	error 1283 interpolator-stop warning axis 4
0189		"Controller generell warning (interpolator stop warning axis 5 [1284])."	Mechanics move hard, crash or problems with the motor control (motor cable) (rated offset exceeded by 10.5%).	Check the mechanics, if necessary replace motor cable, axis amplifier or motor.	error 1284 interpolator-stop warning axis 5
0190		"Controller generell warning (interpolator stop warning axis 6 [1285])."	Mechanics move hard, crash or problems with the motor control (motor cable) (rated offset exceeded by 10.5%).	Check the mechanics, if necessary replace motor cable, axis amplifier or motor.	error 1285 interpolator-stop warning axis 6
0191		"Controller generell warning (interpolator stop warning [1280 - 1299])."	Mechanics move hard, crash or problems with the motor control (motor cable) (rated offset exceeded by 10.5%).	Check the mechanics, if necessary replace motor cable, axis amplifier or motor.	error 1280-1535 interpolator-stop warning axes 1 - 20
0192 - 0194 reserved					
0195		"Controller generell warning ([1280 - 1535])."	General warnings of the robot control system.	Check the warning with the PHG.	error 1280 - 1535 group 5: warnings
0196 - 0201 reserved					
0202		"Controller error group 6 - 12 ([1536 - 3327])."	Drive amplifier parameter error.	Diagnose with PHG.	error 1536 - 3327 group 6 - 12
0203 - 0211 reserved					
0212		"Controller runtime error ([3328 - 3583])."	Combined error message rho 3.2 operating system error.	Restart by pressing reset on PS 75 board, inform ADIC/GRAU Storage Systems service department.	error 3328 - 3583 group 13: P2 run time error at rho 3.2
0213 - 0289 reserved					
0290		"Controller system error ([3584 - 3839])."	Software error in rho 3 operating system.	Restart by pressing reset on PS 75 board, inform ADIC/GRAU Storage Systems service department.	error 3584 - 3839 group 14: system error
0291 - 0297 reserved					



## AMU Error Messages and System Information

---

AMU	Host	AMU Error Message	Cause	Note	rho Error
0298		"Controller another system error ([3840 - 4095])."		System error message not used on operating system TO 03and TO 05L.	error 3840 - 4095 group 15: system error (reserve)
0299		"Controller undefined RHO error ([0001 - 4095])."	Unexpected error of the robot control system.	Restart by pressing reset on PS 75 board, inform ADIC/GRAU Storage Systems service department, verify the error with the PHG.	

## AMU Error Messages and System Information

### 6.3.2 Logic Errors of the Application Program

AMU	Host	AMU Error Message	Cause	Note
0300 reserved				
0301	N001	"Syntax-Error in command string from AMU."	Unidentified command received by AMU.	Check the addresses of the robot control system and the AMU in KONFIG.DAT (pos. 1 and 2), also check the addresses and drive types in the graphical configuration.
0302	N005	"Buffer overflow . Too many messages from AMU to controller."	Commands sent to robot control system that wasn't ready (too many commands received by control system).	Stop the host communication and restart the control system by pressing reset on the PS 75 board.
0303	N102	"Timeout-Error Tower- or E/I/F access is denied."	The robot control system awaits the release by the towers or the I/O unit, or communication with AMU fails.	Check: is I/O door closed, signals present on the input boards, error message of the frequency converter for the Hexa towers. If there is a communication error (log message HOC ERROR COM xx), restart AMU.
0304	N011	"Coordinate send by AMU is out of range "	The target coordinate for the robot is out of the parameterized range.	Check the teach-in points and the KONFIG.DAT values for position limits.
0305	N006	"Command from AMU has been canceled from ."	The control system is not able to execute the AMU command due to a previous error.	Check the log for an earlier error in the command sequence.
0306 - 0400 reserved				

## AMU Error Messages and System Information

### 6.3.3 Handling Errors

AMU	Host	AMU Error Message	Cause	Note
0401	N101	"Crash sensor . Unexpected crash."	Mechanic obstacle in the working area or defective crash sensor.	Reset the control system, check the working area, make a gripper test.
0402	N104	"Tape not in gripper."	The robot cannot properly grab the medium during a Keep.	Check the drive hardware, if necessary re-teach. If the error occurs on several drives, check the handling offset.
0403 (Warning)		"Tape control activated, please check the tape handling for ."	The control system misses a sensor signal from the gripper.	Check gripper and gripper handling, readjust if necessary.
0404	N011	"Illegal argument (tape device) ."	One of the handling sub routines has received an erroneous command.	Check the graphical configuration and the file KONFIG.DAT in rho.
0405	N206	"Flap of requested tape-device for is closed."	The robot cannot take out a medium because the drive's cover is closed.	Check the drive.
0406 (Warning or error)	N207	Flap of requested tape-device for is open."	The robot cannot close the drive's cover.	Check the drive, if necessary correct the robot handling or re-teach it.
0407 (Warning or error)	N105	"Tape in gripper ."	Medium cannot be positioned or can be positioned only after realignment.	Check medium, compartment and robot handling.
0408	N402	"from Gripper during handling ."	Medium not grabbed properly.	Check compartment, gripper jaws, medium and robot handling.
0409 (Warning)		"Common warning ."	Cartridge is not drawn in during Mount, or the Unload button cannot be reached.	Check the drive, if necessary correct the robot handling
0410	N016	"Gripper not in horizontal position ."	Sensor „Gripper horizontal“ not recognized.	Run gripper test, if necessary replace the gripper.
0411	N016	"Gripper not in vertical position ."	Sensor „Gripper vertical“ not recognized.	Run gripper test, if necessary replace the gripper.
0412	N016	"Gripper not open ."	Sensor or valve for gripper opening is defective.	Run gripper test, if necessary replace the gripper.
0413	N016	"Gripper not closed ."	Sensor or valve for gripper closing is defective.	Run gripper test, if necessary replace the gripper.
0414	N016	Gripper not tilt to 0°."	Sensor „Gripper 0°“ not recognized.	Run gripper test, if necessary replace the gripper.
0415	N016	"Gripper not tilt to 7° ."	Sensor „Gripper 7°“ not recognized.	Run gripper test, if necessary replace the gripper.
0416	N016	"Bow not in back position ."	Sensor or valve for bracket backward is defective.	Run gripper test, if necessary replace the gripper.
0417	N016	"Bow not in front position ."	Sensor or valve for bracket forward is defective.	Run gripper test, if necessary replace the gripper.
0418	N104	"Tape lost."	Gripper could not hold onto medium, it has dropped to the archive floor.	Pick up the medium in the archive and let the robot reinsert it, check the robot handling.
0419	N016	"Pressure to low."	Gripper pressure too low.	Check the power supply to the compressor, check for leaks in the hoses (not used on AML/2).

## AMU Error Messages and System Information

AMU	Host	AMU Error Message	Cause	Note
0420	N206	"Tape not ejected from tapedevice for ."	Gripper does not find a medium during Keep.	Check the drive, if necessary increase the time for rewinding in the host software or in the KON-FIG.DAT. If the medium is in the correct position, check the robot handling.
0421	N205	"The position is empty."	Empty compartment has been accessed, may be the medium has been removed manually from the archive.	Check the database.
0422	N112	"Crashsensor during GET from tapedevice."	The robot moves too deep into the drive during Keep or the medium is in a wrong positon.	Check the drive, if necessary check robot handling or re-teach.
0423	N113	"Crashsensor during PUT to tapedevice."	The robot bumps into a mechanic obstacle during Mount.	Check the drive, if necessary check medium handling or re-teach.
0424 (Status message)		" Pressure ok for ."	Pressure is okay again after loss of pressure.	not used on AML/2.
0425 - 0429 reserved				
430		Tape present sensor is defect for %2.	The query pin tracing if a medium is in the gripper, is not activated.	Check the gripper with the test program. Replace defective gripper.
0431 - 0439 reserved				
440	N402	"Rackposition empty for ."	There is a difference between database entry and the compartment in the archive.	Check the database.
0441	N403	"Rackposition occupied for ."	The compartment is already occupied.	Check the database.
0442	N110	"Crashsensor during GET from rack."	The robot bumps into an obstacle while grabbing the medium.	Check the handling, if necessary re-teach and adjust handling values in KONFIG.DAT (pay special attention when using ribbed surface E-cassettes), check the gripper open valve, check the bracket.
0443	N111	"Crashsensor during PUT to rack."	The robot bumps into an obstacle during Put.	Check the robot handling.
0444 - 0445 reserved.				
0446		" did not finish the action at ."	The robot has successfully completed the command execution, but the tower has not.	Check the tower control (frequency converter)
0447 - 0500 reserved				

## AMU Error Messages and System Information

### 6.3.4 Barcode and Teaching Errors

AMU	Host	AMU Error Message	Cause	Note
0501	N016	"Teach-label not recognized ."	Robot does not find a teach label.	Check teach label for cleanness and correct size, repeat the process and watch the red search point of the sensor. If necessary check the power supply to the teach sensor.
0502 (Warning or error)	N304	"Barcode not recognized ."	Barcode label cannot be read by the scanner.	Check the label. If necessary check the reading position with the program.
0503	N304	"Illegal parameter to vision system ."	Error in communication with Vision system.	Check the connection and the communication parameters, if required use new VISION software.
0504	N304	"Wrong record selected ."	Error in communication with Vision system.	Check the connection and the communication parameters, if required use new VISION software.
0505	N306	"Illegal barcode ."	Wrong or other volser has been read.	Check the label, the archive and the database.
0506	N016	"Illegal range during teaching."	The rack has not been reached by the bracket forward sensor.	Start distance for teaching is too high (check coordinates), check the bracket forward sensor.
0507	N304	"Illegal input variables ."	Error in communication with Vision system.	Check the connection and the communication parameters, if required use new VISION software.
050 (Warning)		"retry reading barcode ."	Barcode could not be read during the first reading attempts (4 -> Code 39, 8 -> STK).	Check the label and the reading positions with the test program. Reteach if necessary.
0509 (Warning)		" Different volser reading during action for ."	A different volser has been read during the command execution.	Check the label, optimize the reading position with the test program.
0510	N304	"No Communication between RHO and barcodereadingsystem."	Error in the connection of control system and scanner.	Check the connection, reset Scanner and Rho by switching the main switch off. If necessary replace the interface converter or the gripper.
0511 (Warning)		"Different volser read during insert for ."	A different volser has been read during insertion or inventory.	Check the label, optimize the barcode reading with the test program. Reteach if necessary.
0512 (Warning)		"Vision interface initialized for ."	Vision system has been reset and is reinitialized.	Wait until the Vision system has started. If the reset was unintended check the power supply to the Vision system.
0513		"Communication retry between Rho and barcode scanner for ."	Permanent failure in the communication of control system and scanner.	Check cables and power supply to the scanner or the vision system.
0514 - 0521 reserved				
0522		"Turmaxis not ready"	PMAC control program does not receive answers to control signals sent to the stepper motor board for the turning axis (C).	Switch AMU off altogether and restart the system. Replace the stepper motor control. Replace the gripper.

## AMU Error Messages and System Information

---

AMU	Host	AMU Error Message	Cause	Note
0523 reserved				
0524		Gripaxis not ready	PMAC control program does not receive answers to control signals sent to the stepper motor board for the gripper open/close axis (B).	Switch AMU off altogether and restart the system. Replace the stepper motor control. Replace the gripper.
0525 - 0600 reserved				

## AMU Error Messages and System Information

### 6.3.5 Hardware Errors

AMU	Host	AMU Error Message	Cause	Note	rho Error
0601	N016	"Gripper error , recognized during initialisation."	Gripper error during booting.	Check the gripper.	
0602	N016	"Barcodereadingsystem malfunction , recognized during initialisation."	No connection to the scanner or camera defective during initialization.	Check the connection. If necessary replace the interface converter or the gripper. For operating without barcode reading the scanner test can be interrupted by applying 24 V to E3.0.	
0603	N016	"Vision-system malfunction, recognized during initialisation."	Vision system found defective during initialization.	Check Vision system, fuse in the Vision system may be defective.	
0604	N016	"Battery of controller is empty, recognized during initialisation."	Buffer battery to old or almost depleted.	Replace Rho 3 Buffer battery.	error 1312 Buffer battery voltage too low
0605	N016	"I/O powersupply malfunction, recognized during initialisation."	PIC board or I/O boards are not sourced separately.	Check fuses and cables to the power supply.	
0606 - 0699 reserved					

### 6.3.6 Robot Status Messages

AMU	Host	AMU Error Message	Cause	Note
0700 (Status)		" ready."		Ready message from the robot.
0701	N005	"Arm not in straight position ."	Reflex lightbarrier for stretched out arm position does not send signal to rho (E 6.1) during initialization.	Stretch out the robot arm or replace the sensor.
0702	N003	"Wrong checksum, error in KONFIG.DAT, recognized during initialisation."	Error in the structure of the file KONFIG.DAT.	Check the file KONFIG.DAT.
0703 (Warning)		"Different software version in one or more modules for ."	During a software replacement a module with the wrong version number has been inserted.	Use the entire software of one version.
0710		„Setup-/Testprogram entered by operator, robot not longer ready for AMU“	The test program has been started with <ALT>+<shift>+<deadman> on the PHG	Do not start AMU or host commands as long as the test program is selected.
0798		"Error while reading 'Konfig.dat' at position for ."	Error in the file KONFIG.DAT	Check the file KONFIG.DAT
0799		" is being initialized."	Initialization has been started.	Wait for "ready" message.

## AMU Error Messages and System Information

### 6.3.7 Message Storage Tower

AMU	Host	AMU Error Message	Cause	Note
0800		" ready."		Tower is ready for system.
0801	N015	"Command-queue overflow ."	Commands have been sent to a tower control system that was not ready (too many commands).	Stop host communication and reset control by pressing reset on PS 75.
0802	N011	"Illegal tower address ."	A command has been sent to a tower which is not defined in TKONFIG.DAT.	Check TKONFIG.DAT and the graphical configuration.
0803	N011	"Illegal send address ."	Erroneous command received by AMU.	In the KONFIG.DAT compare the addresses of the tower control with the addresses of the graphical configuration.
0804	N010	"Illegal command ."	Unidentifiable command received by AMU.	In the KONFIG.DAT compare the addresses of the tower control with the addresses of the graphical configuration.
0805	N011	"Illegal segment number ."	Configuration error of the database, software error in the AMU software or communication error.	Check the database, inform ADIC/GRAU Storage Systems service department.
0806	N011	"Illegal robot number ."	Command with wrong robot number received by AMU.	Check the graphical configuration in AMU.
0807		"Wrong telegram type ."	A wrong telegram has been transferred to the tower control system.	Check the configuration.
0808 - 0809 reserved				
0810	N005	"No power for turning ."	EMERGENCY STOP situation of tower control.	Check doors and position of the operating mode selector switch.
0811	N102	" allocated from robot 1."	The robot control program does not run anymore or the release signal from robot control is missing.	Reset the robot control system, check release signal.
0812	N102	" allocated from robot 2."	The robot control program does not run anymore or the release signal from robot control is missing.	Reset the robot control system, check release signal.
0813	N102	" not accessed from robot 1."	The robot control program does not run anymore or the release signal from robot control is missing.	Reset the robot control system, check signal exchange between robot and tower control.
0814	N102	" not accessed from robot 2."	The robot control program does not run anymore or the release signal from robot control is missing.	Reset the robot control system, check signal exchange between robot and tower control.
0815	N102	" not released from robot 1."	The robot control program does not run anymore or the release signal from robot control is missing.	Reset the robot control system, check release signal.
0816	N102	" not released from robot 1."	The robot control program does not run anymore or the release signal from robot control is missing.	Reset the robot control system, check release signal.



## AMU Error Messages and System Information

AMU	Host	AMU Error Message	Cause	Note
0817 (Warning)	N015	" door closed at robot 1."	Sensor „Tower door open for robot 1“ not activated.	Open tower door for robot 1.
0818 (Warning)	N015	" door closed at robot 2."	Sensor „Tower door open for robot 1“ not activated.	Open tower door for robot 2.
0819 reserved				
0820		" has no reference done"	Quadro tower not referenced.	Check the reference switches, reboot the control system.
0821 (Warning)		„Different software version in one or more modules for .“	During a software replacement a module with the wrong version number has been inserted.	Use the entire software of one version.
0822 - 0840 reserved				
0841		"did no reference ."	<p>During the reference movement the input of the reference point switch is not activated.</p> <ul style="list-style-type: none"> <li>The Hexa tower turns at low speed and then stops on a segment: reference switch defective</li> <li>The Hexa tower turns continuously: relay K5 (frequency converter release) “ON” continuously (relay jammed).</li> <li>The Hexa tower does not turn anymore: relay K6 (motor contactor) defective.</li> </ul>	<p>Check the cabling of the Hexa tower, the frequency converter and the Hexa tower motor.</p> <ul style="list-style-type: none"> <li>Check the reference switch and replace it if necessary.</li> <li>Check the relay K5 and replace it if necessary.</li> <li>Check the relay K6 and replace it if necessary.</li> </ul>
0842		"inpos-sensor not detected at ."	<p>The INPOS sensor is not activated during a Hexa tower command execution.</p> <ul style="list-style-type: none"> <li>The Hexa tower stops immediately after the first rotation: INPOS sensor defective.</li> <li>Position of the Hexa tower is not reached: Relay K4 (Hexa tower running fast).</li> <li>Hexa tower does not turn at all: no release of the frequency converter (relay K5)</li> <li>Hexa tower does not turn anymore: relay K6 (motor contactor) defective</li> </ul>	<p>Check the cabling of the Hexa tower, the frequency converter and the Hexa tower motor.</p> <ul style="list-style-type: none"> <li>Check the INPOS sensor and replace it if necessary.</li> <li>Check relay K4 and replace it if necessary.</li> <li>Check relay K5 and replace it if necessary.</li> <li>Check relay K6 and replace it if necessary.</li> </ul>
0843		"Problem with check-sensor or frequency convertor at ."	<p>The CHECK sensor is not activated on the reference point after a reference movement.</p> <ul style="list-style-type: none"> <li>Hexa tower turns a little and then stops in undefined position.</li> </ul>	<p>Check the cabling of the Hexa tower, the frequency converter and the Hexa tower motor.</p> <ul style="list-style-type: none"> <li>Check the CHECK sensor and replace it if necessary.</li> </ul>

## AMU Error Messages and System Information

AMU	Host	AMU Error Message	Cause	Note
0844		" did not reach it's position."	The CHECK sensor is not activated during a Hexa tower command execution. • Hexa tower turns to a segment, corrects in both directions and then stops in undefined position.	Check the cabling of the Hexa tower. • Check the CHECK sensor and replace it if necessary.
0845		"Problem with the frequency convertor at ."	The input E 6.0 „Hexa tower stands still“ is not activated (after a rotation of the Hexa tower)	Check the frequency converter and the cabling.
0846		"Robot did not finish the action at ."	The tower has completed the command execution, but the robot has not.	Check the robot control system.
0847 - 0896 reserved				
0897		"Initialisation failed "	Error during the reference movement.	Check the reference point switch, restart the control system.
0898 (Status)		" ready for manual operation."		Tower is ready for manual operation.
0899 (Status)		" is being initialized."	Tower is referencing.	Wait until reference movements are complete.

### 6.3.8 I/O Unit Messages

AMU	Host	AMU Error Message	Cause	Note
0900 (Status)		" ready."		The I/O unit has been initialized correctly.
0901 (Status)		"DET-communication malfunction ."	Communication error between AMu and operating panel I/O unit/A (BDE)	Check communication parameters, interface and cable, replace BDE if necessary.
0902	N501	"Error opening or closing EIF-door."	Signals for door open, door closed not recognized.	Call up test program for I/O unit/A and check the signals, if necessary replace sensors of BDE
0903	N501	"Door not closed at initialization ."	Door for I/O unit/A open during power-up.	Close door.
0904	N015	"Position not reached ."	Turning error on I/O unit A.	Call up test program for I/O unit/A and check the signals, if necessary replace sensors, frequency converter or BDE.
0905	N015	"Problembox not in correct position ."	Sensor for position monitoring of the problem box of I/O unit/A is not active.	Check the position of problem box. Call up test program for I/O unit/A and check the signals, if necessary replace sensors or BDE.

## AMU Error Messages and System Information

AMU	Host	AMU Error Message	Cause	Note
0906	N015	"Problembox not in correct position at initialization ."	Sensor for position monitoring of the problem box of I/O unit/A is not active during power-up.	Check the position of problem box. Call up test program for I/O unit/A and check the signals, if necessary replace sensors or BDE.
0907	N015	"Position not reached at initialization ."	Turning error of I/O unit/A during program start	Call up test program for I/O unit/A and check the signals, if necessary replace sensors, frequency converter or BDE.
0908	N102	"Timeout-error while waiting for tower release ."	Release signal from rho missing.	Call up test program for I/O unit/A and check the signals, if necessary replace sensors, frequency converter or BDE.
0909	N015	"Data lost ."	Communication error (loss of data) between AMU and operating panel of I/O unit/A (BDE).	Check communication parameters, interface and cable, replace BDE if necessary.
0910	N015	"Error in 3964 communication ."	Communication error (protocol error) between AMU and operating panel of I/O unit/A (BDE).	Check communication parameters, interface and cable, replace BDE if necessary.
0911	N015	"Error in AMU datastring ."	Communication error (loss of data) between AMU and operating panel of I/O unit/A (BDE).	Check communication parameters, interface and cable, replace BDE if necessary.
0912	N102	"Timeout-error during robot access ."	Timeout of wait time at the I/O unit during a robot access.	
0913	N102	"Timeout-error while waiting for release after robot access ."	Timeout at the I/O unit after a robot access.	
0914	N102	"Timeout-error while waiting for problembox release ."	Timeout of wait time for release from problem box.	
0915 (Status)		" turned by operator."	Problem box has been turned by operator.	only for I/O unit/A
0916 (Warning)		" not turned by operator."	Problem box has been unlocked but not turned by 180° by the operator	only for I/O unit/A
0917		" was turned by operator, action was not completed."	Handling box of I/O unit/A has been requested but the door has not been opened.	only for I/O unit/A
0918 - 0920 reserved				
0921 (Warning)		"not opened by operator."	Problem box of I/O unit/A has been requested but not been turned by operator.	only for I/O unit /A
0922 (Status)		" empty."		Problem box is empty.
0923 (Warning)		" not empty."		Problem box is not empty.
0924 (Warning)		" requested by operator, nothing changed."	Handling box of I/O unit/A has been requested but the door has not been opened.	only for I/O unit/A

## AMU Error Messages and System Information

AMU	Host	AMU Error Message	Cause	Note
0925 (Status)		"Closed."	Insertion or ejection has been requested or the door of I/O unit/B has not been properly closed during initialization (signal „door closed“ missing).	Close I/O unit/B door properly by lightly pressing against the door, if necessary readjust door switch.
0926 (Status)		" Shutter need to much time for closing."	The signal to close the shutter has not become active.	Check the sensor for shutter closed and the shutter drive.
0927		AML message	The signals for the handling boxes in the I/O unit are messing.	Put the missing handling boxes into the I/O unit. Check the input signals.
0928 - 929 reserved				
0930		Operator request %2 handling at %5.	The request button at HICAP AML/J has been actuated.	The system now expects a ROSO command from the host.
0931		%2 at %5 ready for operator handling	Door lock on HICAP has been opened.	Within 60 seconds all HICAP doors can be opened now.
0932		%2 opened by operator	HICAP doors were opened.	The system remains stopped until the doors are closed again and the <Control ON> button (S2) at the control cabinet has been pressed.
0933 - 979 reserved				

## AMU Error Messages and System Information

### 6.3.9 Automatic Data Switch Messages

AMU	Host	AMU Error Message	Cause	Note
980		ADS is switched to this AMU.(Automatic Mode)	ADS is connected to the controller while the switch is in automatic mode (AMU is in the status BUD active).	Check if the hosts are connected to the correct AMU.
981		ADS is switched to other AMU.(Automatic Mode)	ADS is not connected to the controller while the switch is in automatic mode (AMU is in the status BUD passive)	Check if the hosts are connected to the correct AMU.
982		ADS is switched to this AMU.(Manual Mode)	ADS has been switched over manually. AMU is connected to the controller.	You must switch over to automatic, to operate the dual-AMU.
983		ADS is switched to other AMU.(Manual Mode)	ADS has been switched over manually. AMU is not connected to the controller.	You must switch over to automatic, to operate the dual-AMU.
984		Syntax-Error in command string from AMU to ADS.	Error in the command string syntax sent to ADS.	Repeat the command. Inform the Customer Help Desk at ADIC/GRAU Storage Systems.
985		3964R communication error (ADS).	Error in the transfer protocol 3964R to ADS.	Repeat the command. Check the interface parameters of AMU. Inform the Customer Help Desk at ADIC/GRAU Storage Systems.
986		ADS hardware error:	Memory error in ADS.	Check the power supply and the battery of the ADS. Replace the ADS.
987- 1000 reserved				

## AMU Error Messages and System Information

### 6.3.10 AMU Information and Error Messages

AMU	Host	AMU Error Message	Cause	Note
1001		"Internal Error in AMU System Software.	Software module in AMU faulty.	Check the correct configuration, correct syntax in the commands, restart AMU.
1002	N002	"Event is unknown for eventhandler ."	Missing software module.	Possibly software installation error, check the program modules (especially KRNSET.DLL).
1003	N005	"The module cannot be loaded, rc =."	Missing software module.	Check your .DLL files in directory C:\AMU\DLL
1004	N005	"The module cannot be linked, rc =."	Missing software module.	Check your .DLL files in directory C:\AMU\DLL
1005 (Info)		"The module is starting..."	Software module is starting.	Wait for the start message of all software modules before entering commands.
1006 (Info)	N005	"The module is started."	Software module has been started.	
1007 (Info)	N005	"The module is not started because of an error."	Software module has abandoned start because of an error.	Check the configuration or the software modules. Stop all modules still running. Restart the system.
1008 (Warning)		"Cannot find an ICON file in startup."		Restart OS/2 and check the *.INI files and directories for the correct ICON file.
1009 (Warning)	N005	"Cannot find the directory ."	Error in directory name.	Change the name of the directory and try it again.
1010 (Warning)	N005	"Cannot find the drive ."	Error in drive name.	Change the name of the drive and try it again.
1011 (Info)	N005	"There was an error starting up the AMU."	Errors during start of AMU.	Check the configuration AMUINI.INI or AMUCONF.INI.
1012	N005	"There's no in the current directory or in the DPATH."		Look at the AMU Installation Guide and check your entries in CONFIG.SYS.
1013	N003	"There's no entry in AMU.INI."		Look at the AMU Installation Guide and check your entries in AMU-CONF.INI or AMUINI.INI. in the configuration submenu.
1014	N005	"The command cannot be processed because of an initialization error."		Look at the AMU Installation Guide, look in AMU - Log for initialization errors and change the missing or wrong configuration information.
1015 (Warning)	N003	"There's no entry in AMU.INI."		Look at the AMU Installation Guide and check your entries in AMU-CONF.INI or AMUINI..INI in the configuration submenu.
1016	N005	"There's not enough memory. Function: ."		Look at the CONFIG.SYS, there should be MEMMAN=SWAP,MOVE,...; there should also be enough space on disk to swap/page segments/pages out.

## AMU Error Messages and System Information

AMU	Host	AMU Error Message	Cause	Note
1017	N003	"Service in .INI couldn't be started."		Look at the AMU Installation Guide and check your service entries in AMUCONF.INI or AMUINI.INI.
1018	N003	"Configuration data couldn't been written."		Look at the AMU Installation Guide and check AMU.INI.
1019	N005	"HOC detects errors for partner ..: module in HocInit returns rc ..."		Look at the AMU Installation Guide and check your service entries in AMU.INI.
1020 (Warning)	N005	"None of the defined communication partners could be found. Module: ."		Look at the AMU Installation Guide and check your service entries in AMU.INI.
1021 (Info)	N005	"HOC detects new state INACTIVE for Partner ."		
1022 (Info)		"HOC detects new state PENDING INACTIVE for Partner ."		
1023 (Info)		"HOC detects new state ACTIVE for Partner ."		
1024 (Info)		"HOC detects new state PENDING ACTIVE for Partner ."		
1025	N010	" KRN could't identify message: "		The given message could not be identified. Try to detect, whether the syntax of the message command was correct.The command is not an host command. Perhaps it is a command reserved for console operating only.
1026 (Warning)	N010	"Not supported ABBA/1 command: "		Discontinue use of ABBA/1 commands. Look at the AMU Operating Guide for valid new commands.
1027 (Warning)	N011	"Missing or wrong data was given with the command: Option: ."		The host command format was wrong. AMU received a command with missing or wrong data. Inform technical or host software support.
1028 (Info)		<-- "		Your host is sending commands in ABBA/1 format. They are being converted by AMU.
1029 (Info)	N002	"The ABBA/1 command was not in proper format:1 "		Your host sent a command that seemed to be in ABBA/1 format. But the format of the command was wrong. Inform technical or host software support.
1030 (Info)		"Start of command : "		AMU just received a host command and did start processing it.
1031 (Info)		"<-- "		Data was sent by a partner.
1032	N301	"The given volser could not be found in database."		Check the command and your archive catalog.
1033	N401	"The given position could not be found in database."		AMU could not find the given position in database.
1034	N011	"No robot could be selected."		Either there is no robot attached to the given source and/or target coordinate or the source and target coordinates cannot be handled by the same robot. Check the command and the archive entries.
1035	N004	"A severe error in archive mirror has occurred. Volser: , Coordinate: "		A mismatch in archive entry has been found. Check archive mirror.
1036 (Info)				This is an information about internal structures of the AMU !

## AMU Error Messages and System Information

AMU	Host	AMU Error Message	Cause	Note
1037 (Warning)		"HOC error: "		Look for the specific error, AMU Communications Subsystem HOC will try to recover.
1038	N002	"Unknown option in host command ."		AMU found an unknown option in the given host command. Command cannot be executed.
1039 (Info)		"A command is processed in function : processflag = ."		AMU is processing a command
1040 (Info)		"AMU INFO: "		AMU internal INFO
1041 (Info)		"AMU sent answer for ."		Execution of a command is completed. The execution can be successful or not. Analyze return code of answer string for result.
1042 (Info)		"Event -execution."		This is a Trace Record.
1043	N005	"There is no communication partner connected to "		Check if the communication partner is present at the specified Com-Port.
1044	N005	Failure setting the device control block of "		Possible hardware problems, Please call technical Support !!
1045	N005	"Failure getting the device control block of "		Possible hardware problems, Please call technical Support !!
1046	N005	"Failure setting the modem control signal of "		Possible hardware problems, Please call technical Support !!
1047	N005	"Failure setting the line characteristics of "		Possible hardware problems, Please call technical Support !!
1048		"Failure setting the baud rate of "		Possible hardware problems, Please call technical Support !!
1049	N005	"Failure opening "		Possible hardware problems, Please call technical Support !!
1050	N005	"Could not start the read thread for "		Please call technical Support !!
1051	N005	"Could not start the write thread for "		Please call technical Support !!
1052 (Info)		"The module ended normally."		The module ended normally.
1053		"The module ended abnormally, because of a software trap."		The module ended abnormally.
1054		The module ended abnormally, because of a kill process command."		The module ended abnormally.
1055		"The module ended abnormally, because of a hardware error abort."		Please call technical Support !!
1056 (Info)				This is a Trace Record.
1057 (Info)		"The module is stopped."		The AMU module is stopped.
1058 (Info)		"The module did not stop correctly due to an error."		The AMU module isn't stopped.
1059	N004			The OS/2 Database Manager tells us about an info, warning or error.
1060 (Warning)		"The database will be created."		The database will be created from the OS/2 database engine.
1061 (Warning)		"The database was created."		The database was created from the OS/2 database engine.
1062 (Warning)	N004	The database wasn't created, there is an OS/2 database engine error."		The database wasn't created from the OS/2 database engine, look for a related database engine message.



## AMU Error Messages and System Information

AMU	Host	AMU Error Message	Cause	Note
1063 (Warning)		"The table will be created."		The table will be created from the OS/2 database engine.
1064 (Warning)		"The table was created."		The table was created from the OS/2 database engine.
1065 (Warning)	N004	"The table wasn't created, there is an OS/2 database engine error."		The table wasn't created from the OS/2 database engine, look for a related database engine message.
1066 (Warning)		"The module will be bound."		The module will be bound against the OS/2 database.
1067 (Warning)		"The module was bound successfully."		The module was bound against the OS/2 database.
1068 (Warning)	N004	"The module wasn't bound successfully."		The module was not bound against the OS/2 database, look for a related database engine message.
1069 (Warning)		"Building started."		The object will be build in the OS/2 database.
1070 (Warning)		"Building ended successfully."		The object is built in the OS/2 database.
1071 (Warning)	N004	"Building ended with an error."		The object cannot be built in the OS/2 database, look for a related database engine message.
1072 (Warning)		" "		
1073 (Warning)		" "		
1074 (Warning)		"Begin with reading the datastring from "		
1075 (Info)		"ARC "		This is a Trace Record.
1076 (Info)		"***> "		AMUP just sent message to AMU.
1077 (Info)		"***> "		AMUP just sent response to AMU.
1078 (Info)		"----> to "		AMUP just sent data to Rho.
1079				
1080				
1081	N005	"The AMUPATH environment variable isn't set correctly, can't find AMUINI.INI."		Correct the SET for AMUPATH in CONFIG.SYS.
1082	N302	"The requested position does not contain a tape (Archive catalogue)."		Check the command, make an inventory on the requested position.
1083	N202	"The requested drive is not empty (Archive catalogue)."		Check the command, make an inventory on the requested tape device.
1084	N001	"The specified requester is not known to AMU."		Check the command, and the configuration of the system. AMU received a message by a requester that it does not know. AMU is not allowed to talk to unknown hosts.
1085	N005	"There is no robot in configuration at all."		Check the configuration of the system. AMU received a message for a robot and there is no robot configured.
1086	N005	"There is no robot available at this moment."		Check the message string. AMU received a message for a robot but there is no robot available.

## AMU Error Messages and System Information

AMU	Host	AMU Error Message	Cause	Note
1087 (Info)		"ARC -exec Opt: "		This is a Trace Record.
1088 (Info)				Making/ checking the BCC according to the AML Protocol
1089 (Info)				Sending an ACK or NAK to the connected partner.
1090 (Info)				Received an AML control character from the connected partner.
1091	N205	"The requested position does not contain a tape (checked by robot)."		Check the command, make an inventory on the requested position.
1092	N204	"The requested drive is not empty (checked by robot)."		Check the command, make an inventory on the requested tape device.
1093 (Info)				Checking the received string according to the AML protocol.
1094	N203	"The requested drive is empty (Archive catalogue)."		Check the command, make an inventory on the requested tape device.
1095	N403	"The requested position is not empty (Archive catalogue)."		Check the command, make an inventory on the requested position.
1096 (Info)				"The transmitted BCC is different from the calculated BCC.
1097 (Info)				There is no ETX in the transmitted data string.
1098	N003	"AMUP can't open file ."		Make sure that the teachpoint-file exists in the proper directory or create new file.
1099	N003	"The input file is too large."		Too many teach points. Check your configuration.
1100	N003	"Unable to read file ."		File corrupted, please recreate file.
1101	N003	"AMUP can't close file ."		
1102	N011	"Coordinate for not found in file ."		Teach given coordinate.
1103	N011	"Too many messages for AMUP."		
1104	N001	"The message with the sequence number is unknown for AMUP."		The given Rho-message is not expected by AMUP.
1105	N001		Error in the message from rho3	Please inform technical support for assistance.
1106	N016	Inproper coordinate resulted in divide by zero."		Check your physical coordinates.
1107	N301	Krn searched for ."		No help.
1108	N001	"The given rho-command is invalid."		
1109	N016	"Too many messages to rho."		
1110	N102	"Rho did not respond to AMUP-message, timeout error."		Test connection to rho.
1111	N001	"The given AMU-command is invalid."		AMUL sent an unexpected command to AMUP.
1112 (Info)	N001	"All coordinates for will be created in file ."		The given coordinate will be added to the specified file.
1113	N016			rho sent an error to AMUP.

## AMU Error Messages and System Information

AMU	Host	AMU Error Message	Cause	Note
1114 (Info)		"ARC Format "		This is a Trace Record.
1115 (Info)		"The module is already started."		Look, if the module is really started twice.
1116 (Info)		"File will be created."		The specified file will be created.
1117		Unable to write to file ."		
1118		Unable to set filepointer in file ."		
1119 (Info)		"Item in dialog clicked"		The user clicked on the item in the Action Bar.
1120 (Info)		"<-- ."		Your host is sending commands in ABBA/1 format. They are being converted by AMU.
1121 (Warning)	N306	Inconsistency during INVT detected. Coordinate: . expected volser: , volser in fact: ."		Make an update to the archive catalog.
1122	N007	"A sequence number has been used twice. Therefore the second command cannot be processed."		Make sure that hosts don't use a sequence number twice. AMU doesn't process the second one.
1123	N007	"The host(s) sent more commands than executable at one time."		Make sure host(s) don't sent so many commands at one time.
1124		"Could not start the read thread for HACC session "		Please call technical Support !!
1125		Could not start the write thread for HACC session "		Please call technical Support !!
1126		"Could not start the thread wait for presentation space for HACC session "		Please call technical Support !!
1127		"Failure connect to Presentation Space for session with session ID "		Possible hardware problems, Please call technical Support !!
1128 (Info)				For detailed Informations use EHLLAPI Programming Reference 1.3
1129 (Info)				
1130 (Info)				
1131	N007	"Command cannot be executed in simulation or configuration mode."		AMU cannot execute an inventory command in simulation or configuration mode.
1132 (Info)				Test connection and communication parameters to the rho Controller.
1133 (Info)		"The priority for is set correct."		Priority is set correct for the given thread.
1134 (Warning)		"The priority for wasn't set correct, OS/2 errorcode: "		Priority isn't set correct for the given thread. Note the error code.
1135 (Info)		"--> "		Execution of a command is completed. The execution can be successful or not. Analyze return code of answer string for result.
1136	N403	"The requested target device is not empty (Archive catalogue) ."		Check the command, make an inventory on the requested target device.
1137	N402	"The requested source device is empty (Archive catalogue) ."		Check the command, make an inventory on the requested target device.

## AMU Error Messages and System Information

AMU	Host	AMU Error Message	Cause	Note
1138	N005	"The desired robot is not available."		AMU received a message for a robot, but the desired robot is not available.
1139	N007	"The desired robot is not known to AMU."		AMU received a message for a robot, but the desired robot is not known to AMU.
1140	N011	The desired coordinate is wrong."		AMU received a message that contained a coordinate, which is illegal for the given command.
1141		"The update of was not succesful."		AMU should make an update of an entry in archive catalogue. This update did not work. There is the danger of a mismatch in archive catalogue now! Check the requested coordinate or volser!
1142 (Info)		"The inventory is being terminated because of an error."		The inventory is being terminated because of an error.
1143	N001	"Stringlength of Towerstring is incorrect."		String length error.
1144	N001	"Stringlength of Robotstring is incorrect."		String length error.
1145	N001	"Stringlength of EIF-String is incorrect."		String length error.
1146	N001	"Stringlength of AMUL-string is incorrect."		String length error.
1147	N001	"Stringlength of rho- or MET-string is incorrect."		AMUP received string with unknown length.
1148	N005	"AMU canÔt send string to partner ."		Check connection to specified partner.
1149 (Info)		"<---- "		AMUP just received data from Rho.
1150 (Info)		" <**** "		AMUP just received data from AMUL.
1151 (Info)		"There is no entry in configuration at position "		AMUP just received data from AMUL.
1152	N502	"This coordinate can not be updated because it's not the type of coordinate you expected it to be. CTYPE = ."		The ABBA/1 command expected an update of a coordinate. The coordinate was expected to be for example a insert device but in AMU archive catalogue it is an eject device. Therefore AMU doesn't update the coordinate.
1153	N 505	"All positions in problem box are occuppied. The running procedure must be stopped because the problem box is required."		Empty the problem positions and tell AMU-Console that you did so. Then work can continue.
1154	N007	"The currently running insertion of tapes could not be finished because of an error in processing".		Look in logfile for further information about the error that occurred.
1155 (Warning)	N305	"The currently running insertion of tapes is finished. There wasn't found any tape in insert positions."		Look in logfile for further information about the error that occurred.
1156 (Info)	N302	"The insert array does not contain a tape."		Look into the archive catalog, when there are tapes in insert array and this message did occur.
1157	N503	"There is no free eject position in EIF-device."		Unload your eject positions in the EIF-device.

## AMU Error Messages and System Information

AMU	Host	AMU Error Message	Cause	Note
1158	N011	"The desired tower is not known to AMU."		AMU received a message for a tower, but the desired tower is not known to AMU.
1159	N011	"The desired EIF-device is not known to AMU."		AMU received a message for an EIF-device, but the desired EIF-device is not known to AMU.
1160 (Info)	N011	"Change of home position occurred."		
1161 (Warning)	N011	The archive catalog will be deleted.		
1162	N302	"The requested tape is not in a storage position."		May be it is ejected or mounted.
1163	N016	AMUP moved tape back to the source position."	A crash occurred at the target device	Check the target coordinate and teach the target device, if necessary.
1164	N101	"AMUP tells AMUL to move a tape to the problembox."	Problem occurred in the AML System.	Find the problem in the AMU-Log and reinsert the tape from the problem box.
1165	N016	"Coordinate check failed during teaching."		The returned coordinate from robot is out of range.
1166	N201	"The device is unknown to the archive catalog. "	Wrong device specification in the command	Check your command and retry.
1167 (Info)		"All coordinates for will be deleted in file ."		The given coordinate will be removed from the specified file.
1168		"There was no command found, that could be purged out of queue."		
1169 (Info)	N014	"The command in process is being purged."		
1170	N102	" did not respond to AMUP-message , timeout error."	AMU gets no answer from robot-control.	Check robot control and connection to robot-Rho.
1171	N102	" did not respond to AMUP-message , timeout error."	AMU gets no answer from tower-control.	Check robot control and connection to tower-Rho.
1172		" did not respond to AMUP-message , timeout error."	AMU gets no answer from EIF-control.	Check connection to control of EIF-device.
1173		"The drive cannot be closed."		
1174 (Info)		"AML MANAGEMENT UNIT is now ready to process commands."		
1175	N504	"The tape was moved to the problem box because of an severe error."	A problem, perhaps a crash has occurred in the AML System.	Find the problem in the AMU-Log and reinsert the tape from the problem box.
1176				You configured an HACC that is not valid for EHLL.
1177				EHLLAPI cannot connect to the Communication Manager's Presentation Space, write down the error number if greater 0 and see EHLLAPI Programming Reference for further information.

## AMU Error Messages and System Information

AMU	Host	AMU Error Message	Cause	Note
1178				EHLLAPI cannot release the Communication Manager's Presentation Space, write down the error number if greater 0 and see EHLLAPI Programming Reference for further information.
1179				EHLLAPI cannot convert Row/position into an absolute Presentation Space position, write down the error number if greater 0 and see EHLLAPI Programming Reference for further information.
1180				EHLLAPI did not find the HACC Mask in the Presentation Space, write down the error number if greater 0 and see EHLLAPI Programming Reference for further information.
1181				EHLLAPI cannot read Information from HACC Mask in the Presentation Space, write down the error number if greater 0 and see EHLLAPI Programming Reference for further information.
1182				EHLLAPI cannot find the MVS Unit Adress/ LU-Adress in HACC Mask, write down the error number if greater 0 and see EHLLAPI Programming Reference for further information.
1183				EHLLAPI cannot find the expected HACC Version in HACC Mask, write down the error number if greater 0 and see EHLLAPI Programming Reference for further information.
1184	N302	"There was no clean tape found in database "		Check if there are clean tapes entered in database.
1185	N016	"The robot that was found to do the job is not configured in AMU.INI."		There is a mismatch between the robot entries in archive catalog and the robots that are configured in AMUINI.INI.
1186 (Info)		Initialization request from ."		MET needs initialization after a reset.
1187	N016	"The coordinate is invalid."		Verify your entry in the dialog box.
1188 (Info)		"Configured robot(s) (not) ready for AMU."		If all configured devices are ready, you can start working.
1189 (Info)		"AMU received autorepeat but command was still in progress."	Command needs more time.	Wait until the end of the command execution.
1190 (Info)		"Configured tower(s) ready for AMU."		If all configured devices are ready, you can start working.
1191	N011	"The desired tower is not available."		AMU received a message for a tower, but the desired tower is not available.
1192		"AMUP tells AMUL to move a tape with unknown volser to the problembox."	Robot has an unknown tape in the gripper and will move this tape into the problem box.	Find the error in the AMU-Log and reinsert the tape from the problem box.
1193 (Info)		Request from canceled."		Request from the given controller cancelled, because there is more than one request at the same time.

## AMU Error Messages and System Information

AMU	Host	AMU Error Message	Cause	Note
1194	N204	The keep of the desired drive has not been finished, yet."		The host sent a mount command but the keep for the required tape device was not answered, yet.
1195 (Info)		"The EIF-Device No. Segment was opened by an operator."		
1196	N503	"The eject-rack is full, AMUP moved tape back to the source position."		We had a crash during move to the eject-area, so we suppose the eject-area is full. The tape is back in it´s source-position.
1197	N503	"The eject-rack is full, AMUP tells AMUL to move a tape to the problembox."		We had a crash during move to the eject-area, so we suppose the eject-area is full. The attempt to move the tape back was unsuccessful.
1198 (Info)		"Check of EIF-Device No. Segment is complete."		
1199 (Info)		"A pending KEEP-Command was purged."		
1200 (Info)		"This machine is a AML MANAGEMENT UNIT ."		
1201	N005	"AMU is still not ready. Command is lost."		After being started AMU needs some time until it is entirely initialized and ready.
1202 (Warning)		"The database will be updated."		The database records will be adjusted to the entries of the configuration file.
1203 (Warning)		"The database was updated."		The database records are now adjusted to the entries of the configuration file.
1204 (Warning)		"The database was not updated."		The database records were not adjusted to the entries of the configuration file.
1205 (Warning)		"Begin of reading the database configuration."		The database configuration will be read.
1206 (Warning)		"End of reading the database configuration."		The database configuration was read successfully.
1207 (Warning)		"Unsuccessful end of reading the database configuration."		The database configuration read reports an error.
1208 (Warning)		"Begin of reading the configuration file."		The configuration file will be read.
1209 (Warning)		"End of reading the configuration file."		The configuration file was read successfully.
1210 (Warning)		"Unsuccessful end of reading the configuration file."		The configuration file read reports an error.
1211 (Warning)		Begin of computing the differences of database and configuration file."		The differences of database and configuration file will be computed.
1212 (Warning)		"End of computing the differences."		The differences of database and configuration file are computed successfully.
1213 (Warning)		"Unsuccessful end of computing the differences."		The computing of the differences reports an error.
1214 (Warning)		"Begin of the adjustment of the database."		The database will be adjusted.
1215 (Warning)		"End of the adjustment of the database."		The database has been adjusted successfully.
1216 (Warning)		"Unsuccessful end of the adjustment of the database."		The adjustment of the database reports an error.

## AMU Error Messages and System Information

AMU	Host	AMU Error Message	Cause	Note
1217 (Warning)		"No difference found, therefore no adjustment required."		There are no differences between database and configuration file. The database requires no adjustment.
1218 (Warning)		"Adding device ."		The shown device will be added.
1219 (Warning)		"Device was added."		The shown device has been added successfully.
1220 (Warning)		"The device could not be added."		"The DBM reports an error at addition of device.
1221 (Warning)		"Deleting device ."		The shown device will be deleted.
1222 (Warning)		"Device was deleted."		The shown device has been deleted successfully.
1223 (Warning)		"The device could not be deleted."		The DBM reports an error at deletion of device.
1224 (Warning)		"Begin of the acceleration of the database."		The database will be accelerated by creating database indices.
1225 (Warning)		"End of the acceleration of the database."		The database indices were created successfully.
1226 (Warning)		"Error during device Configuration Utility Procedure Occurred."		Error in DevCfg.c. Look at Log.
1227 (Warning)		"Begin of database editing: "		The database records for the given Coordinate Range will be updated.
1228 (Warning)		The database edit was done successfully."		The database records have been updated now.
1229 (Warning)		"An error occurred during the database update "		The database records have not been updated
1230 (Warning)		"Begin of database update: "		The database records for the given Coordinate Range will be updated.
1231 (Warning)		"The database update was done successfully."		The database records for the given Coordinate Range have been updated now.
1232 (Warning)		"An error occurred during the database update "		The database records for the given Coordinate Range have not been updated.
1233	N012	The command can no longer be purged."		The command is already in progress. Therefore it cannot be purged and ready.
1234		"The module is already running."		The module is already running. Be sure that the module is terminated before restart.
1235		" has no access to ."		Verify your entry in the dialog box.
1236		"There was no scratch tape found in database "		Use Archive Catalog Management to check if there are scratch tapes entered in database.
1237	N401	"There is no dynamic position defined in your AML system "		
1238		"All dynamic positions in your AML system are occupied "		
1239 (Warning)		"Manual operation started."		Manual operation has been requested. All commands have to be executed by an operator.



## AMU Error Messages and System Information

AMU	Host	AMU Error Message	Cause	Note
1240 (Warning)		"Manual operation stopped."		Automatic operation has been requested. All commands will be executed by robot(s).
1241	N012	Command has not been executed by operator."		The requested command could not be executed by the operator or the operator refused to execute the command.
1242		"Command not accepted. Other command pending."		The requested command could not be executed. Only one command is allowed at a time and another command is still pending.
1243		"Reserved."		
1244		"The Rho error number is unknown for Rho File Manager"		
1245		"Timeout-error while waiting for Rho response"		
1246		"AML Message."	Error during file transfer	Check the error message in the Rho File Manager.
1247 (Info)		Start of communication: "	Communication with rho has started	
1248 (Info)		"End of communication: "	Communication with rho has ended	
1249		"AML message"	Error on the interface	Check the error message in the Rho File Manager.
1250 (Info)		"RFM Function: "	Rho File Manager call- up of function	
1251 (Info)			Message of the Rho File Manager	
1252 (Info)		" of listing the Rho contents "		Message of the Rho File Manager on the list command.
1253 (Info)		" of sending the file to the Rho "		Message of the Rho File Manager on the send command.
1254 (Info)		" of receiving the file from the Rho "		Message of the Rho File Manager on the receive command.
1255 (Info)		" of deleting the Rho file "		Message of the Rho File Manager on deleting a rho file.
1256 (Info)		" of renaming the Rho file "		Message of the Rho File Manager on renaming a rho file.
1257 (Info)		"Rho Error "		Control system error during operation with the rho File Manager.
1258		"Missing response to command with seq.nr.: sent to at. The command will be deleted from table in CON.		The module named in the error message may be hanging. Shutdown and restart!
1259		"Open DB-Cursor failed."		The ARC-Modul wasn't able to open the given DB-Cursor. Look for a related database engine message at the Log Control Center.
1260		"Fetch with DB-Cursor failed."		The ARC-Modul wasn't able to fetch a record with the given DB-Cursor from the the database.
1261 (Info)		"Close DB-Cursor failed."		The ARC-Modul wasn't able to close the given DB-Cursor. Look for a related database engine message at the Log Control Center.

## AMU Error Messages and System Information

AMU	Host	AMU Error Message	Cause	Note
1262 (Info)		View in table scoordinates, search by "		Look for a special record in the table amu.scoordinates, search by the given DB-Cursor.
1263 (Info)		"View in table coordinates, search by "		Look for a special record in the table amu.coordinates, search by the given DB-Cursor.
1264 (Info)		"Update in table scoordintes, search by , update "		An update should be made in table amu.scoordinates.
1265 (Info)		"Update in table coordinates, search by , update "		An update should be made in table amu.coordinates.
1266 (Info)		"Start of function "		Message is just for information.
1267		"Internal error in function , returncode "		Error Message for debugging.
1268 (Info)		"Start of ArcEventDispatch function, Event:"		The ARC module received an event, the given event should be executed.
1269		"The database was not deleted."		"The database wasn't deleted by the OS/2 database engine, look for a related database engine message.
1270	N 505	"A tape was carried to the problem box. The problem box is full now."		The problem box has to be emptied. Otherwise the AML/2 system will be blocked, if another move to problem box is necessary.
1271		"The media Types of source- and target coordinate in command %1 do not fit.%0"		E. g. a mount of a VHS cartridge is planned to be executed on a 3480 tape device.
1272 (Info)		"CFG-Info: Scope "%1" : %2 %3.%0"		This is only a information from ConfigurationServer.
1273 (Warning)		"CFG-Warning: Scope "%1" : %2 %3.%0"		This is a Warning from ConfigurationServer.
1274		"CFG-Error: Scope "%1" : %2 %3.%0"		This is a Error from ConfigurationServer.
1275 (Info)		"Database %1 for module %2 is starting...%0"		The START USING DATABASE statement will be performed for this module.
1276 (Info)		"Database %1 for module %2 is started.%0"		The START USING DATABASE statement was performed successfully for this module.
1277 (Info)		"Database %1 for module %2 is not started because of an error.%0"		The START USING DATABASE statement couldn't be performed successfully for this module.
1278 (Info)		"Database %1 for module %2 is stopped.%0"		The STOP USING DATABASE statement was performed successfully for this module.
1279 (Info)		"Database %1 for module %2 did not stop correctly due to an error.%0"		The STOP USING DATABASE statement couldn't be performed successfully for this module.
1280 (Info)		"Grant SELECT, UPDATE on table %1 to PUBLIC failed.%0"		The execution of this SQL-statement failed, look for a related SQL-message.
1281 (Info)		"Database %1 doesn't exist.%0"		Execute Create Archive.
1282 (Info)		"Start of function %1, Input: %2.%0"		Message is just for information.
1283 (Info)		"Grant EXECUTE, BIND on program %1 to PUBLIC was successful.%0"		The privilege to execute or rebind the given program (module) was given to PUBLIC (all users).

## AMU Error Messages and System Information

AMU	Host	AMU Error Message	Cause	Note
1284 (Info)		"Grant EXECUTE, BIND on program %1 to PUBLIC failed.%0"		The execution of this SQL-statement failed, look for a related SQL-message.
1285 (Info)		Starting open the configuration dialog	The window graphical configuration has been opened.	
1286 (Info)		Saving the configuration	The configuration has been saved in the file AMUCONF.INI.	
1287 (Info)		"%1" %2(s) in configuration (%3).		General status message in the configuration dialog.
1288 (Warning)		A medium with unexpected volser was dismounted. Expected volser: %1, dismounted volser: %2.	During operation of the insert/eject compartment of the jukebox unexpected media were found.	Check the label of the optical disk. A manual interference may have occurred.
1289 (Info)		%1.%0	Information or error messages for the backup daemon.	If an error has occurred check the following <ul style="list-style-type: none"> <li>• the file LOCAL.AMU</li> <li>• is the configuration of both AMUs identical?</li> <li>• has the database been prepared with the same codepage?</li> <li>• does the database fit the configuration?</li> </ul>
1290		A command was cancelled because of an error recovery situation by robot %1.		
1291		The file for disaster recovery could not be found.	No file *.dsr is in the directory C:\AMU\RECOVERY	Check if the file selected is in the directory C:\AMU\RECOVERY. Create the file or copy the file into the directory.
1292 (Info)		The eject of media for disaster recovery is finished. End of file reached.		All media listed in the selected disaster recovery file have been ejected. The media can now be taken over by the data processing centre for disaster recovery.

## AMU Error Messages and System Information

---

AMU	Host	AMU Error Message	Cause	Note
1293 (Info)		The Volser %1 for disaster recovery is successfully ejected.		A medium with Eject Disaster has been ejected and can be taken from the I/O unit.
1294 (Warning)		It was necessary to copy one of the inifile.	The files AMU-CONF.INI or AMU-CONST.INI could not be opened.	The files have been replaced by automatically made backup copies. This may mean that the last changes have been lost. Check the configuration.
1295 (Warning)		A conversion of the logical ranges was done, you have to add a name.	Software update to version 2.4.0 from version 2.3.0 or lower.	The types Eject and Insert are no longer available in the database and are automatically converted into the type AMU-Dynamic. To be able to work with these ranges, the I/O units need to be assigned logical ranges with names in the graphical configuration (e. g. E01, I01).
1296 (Info)		DASxxxx	DAS/2 Server Software Message will displayed in Log	Information for the DAS/2 Administrator (☞ DAS Administration Guidel)

## 7 Appendix

---

### 7.1 Terms Used

---

<b>AML</b>	Automatic tape cartridge operating archive; AML software and physical archive. <ul style="list-style-type: none"><li>• /2 means 2nd version</li><li>• /E means Entry</li><li>• /J means junior.</li></ul>
<b>AMU</b>	<b>AML Management Unit</b> Central intelligence of the AML system. Consists of hardware and software.
<b>AMU operating console</b>	OS/2 program for operation of the AML system (CON.EXE).
<b>Archive</b>	The archive consists of: <ul style="list-style-type: none"><li>• physical archive and</li><li>• logical archive.</li></ul> <p>The physical archive consists of storage segments for tape cartridges and optical disks (= media). The logical archive (archive catalog) is the list of volsers assigned to the compartments in the physical archive.</p>
<b>Archive catalog</b>	An OS/2 database with the logical archive. Contains the assignment of volsers to the compartments in the physical archive as well as further vital information about the media and the drives.
<b>Archive coordinates</b>	These define the compartment of a medium in the physical archive.
<b>Barcode label</b>	Label on the medium, contains the volser in a form readable for the robot (barcode).
<b>Click</b>	Short pressing and releasing of the mouse button.

<b>Command, instruction</b>	<p>A command sent to the AML system:</p> <ul style="list-style-type: none"><li>• from the host computer</li><li>• direct operator input at the AMU operating console</li></ul>
<b>Configuration</b>	<p>Determines the structure of the AML system. The configuration specifies the components and their connections.</p> <ul style="list-style-type: none"><li>• host computers</li><li>• AMUs</li><li>• controls</li><li>• storage segments</li><li>• linear shelves</li><li>• robots</li><li>• specials</li><li>• drives</li></ul>
<b>Foreign (non-system) media</b>	<p>Cartridges not listed with a volser in the archive catalog. They are processed by the AML system via the I/O unit.</p>
<b>Handling box</b>	<p>Storage box for media in the I/O unit.</p>
<b>Handling unit</b>	<p>Robot with 3 axes and gripper.</p>
<b>Host computer</b>	<p>Mainframe computer. The data of the host computer is stored in the AML system (archive) on media.</p>
<b>I/O unit</b>	<p>Input/output area. Media are inserted and ejected via the I/O unit. There are three different versions:</p> <ul style="list-style-type: none"><li>• Type A: with turning units</li><li>• Type B: without turning units</li><li>• Type C: manual turning unit</li></ul>
<b>Linear shelf</b>	<p>Storage archive (only one storage level)</p>
<b>Medium</b>	<p>Storage medium in the archive, e. g. a magnetic tape cartridge or optical disk.</p>
<b>Medium mount</b>	<p>Inserting (MOUNT) a medium in a drive is referred to as mounting. Removal of the medium is referred to as unmounting (KEEP).</p>
<b>Operator</b>	<p>Trained operator of the AML system.</p>
<b>Operating panel</b>	<p>Operating panel on the control cabinet for switch-on/off and monitoring of the AML system.</p>

## Terms Used

---

<b>Optical Disk (OD)</b>	Optical storage medium (CD). The optical disk occupies one logical compartment but two volsers (A and B side).
<b>Problem box</b>	Special compartments in the I/O unit. These house: <ul style="list-style-type: none"><li>• unidentified media</li><li>• media in case of robot failure</li></ul>
<b>Quadro tower</b>	Storage archive with 32 segments.
<b>Scratch media</b>	Scratch media are system media released for rewriting. Without a volser they are used to output data (unspecific media request).
<b>Segment</b>	All rows in one column of a storage tower.
<b>System media</b>	System media have a volser, are stored and registered in the archive.
<b>Teaching</b>	Teaching of the robot system.
<b>Teach label</b>	White reference mark; their room coordinates are measured (resolution 1/100 mm). The data then allows the system to compute all points to be accessed by the robot. The coordinates of all points taught are stored in the file KRNREFPT.R0X (X for the respective robot 1 or 2).
<b>Turning unit</b>	Part of the I/O unit/A. In its sections a turning unit houses four handling boxes.
<b>unspecific media request</b>	Mount command for a scratch medium or cleaning cartridge.
<b>Volser, VSN</b>	English: <b>volume serial number</b> An up to sixteen-digit alphanumeric designation. It identifies one medium (cartridge, optical disk) in the archive. Exception: optical disk has one logical compartment but two volsers (A and B side). The volser is attached to the rear of the medium on a barcode label and can be read by the handling unit.

## 7.2 Component Types

### 7.2.1 Drives

Type	Drive Name and Number	Medium	Manufacturer
D1	Colorado T1000	TRAVAN	HP
D2	6380	3480 cassette	COMPAREX
D2	7480	3480 cassette	HDS
D3	6390	3490 cassette	COMPAREX
D3	7490	3490 cassette	HDS
D7	3480 with ACL	3480 cassette	IBM
D7	3580 with ACL	3480 cassette	SNI
D8	3480 with cover	3480 cassette	IBM
D8	3480 with cover	3480 cassette	SNI
D9	5480	3480 cassette	MEMOREX
D9	60/3590E	3490 cassette	MEMOREX
D9	3580 without cover	3480 cassette	SNI
D9	3590	3490 cassette	SNI
D9	3480 without cover	3480 cassette	IBM
D9	3490	3490 cassette	IBM
D9	3490-TA91	3490 cassette	DIGITAL
D9	9309 2	3490 cassette	IBM
DA	ER90	D2	AMPEX
DA	DST 310	D2	AMPEX
DC	8205-8mm	8mm cassette	EXABYTE
DC	DC MK 13	8mm cassette	SNI
DC	7208 011, Mammouth	8mm cassette	IBM
DE	DLT 2000 (modified)	TK cassette	ADIC
DE	DLT 4000 (modified)	TK cassette	ADIC
DF	DDS 7206 005	4 mm cassette	IBM
DF	HP 6400/1300 S (DDS-1)	4 mm cassette	HP
DF	HP 6400/4000 DC (DDS-2)	4 mm cassette	HP
DH	HP 1300	OD 512	HP
DJ	3995 Jukebox	OD 512	IBM
DK	4480	3480 cassette	STK
DL	4490 Silverstone	3480 cassette	STK
DL	9490 Timberline	3480 cassette	STK



## Component Types

---

Type	Drive Name and Number	Medium	Manufacturer
DN	3591	3590 cassette	SNI
DN	3590 Magstar	3590 cassette	IBM
DN	8590	3590 cassette	ADIC
DO	RF7010E, MF for external unit	OD Reflection	PLASMON
DO	RF7010X, MF	OD Reflection	PLASMON
DP	IFD-1300-A Subsystem	OD 512	FUJITSU
DP	OD 1300T	OD 512	HP
DP	OD 6300 650/A	OD 512	HP
DP	NWP-559	OD 512	SONY
DP	MOD 2,6 GB	OD 512	SNI
DP	OS 13	OD 512	SNI
DP	Gigaburst	OD 512	STORM
DQ	M2485	3490 cassette	Fujitsu
DQ	M2483K-3480/90	3490 cassette	Fujitsu
DQ	LMS TD 3610	3490 cassette	Philips
DQ	7492	3480 cassette	HDS
DS	3588-GL	3490 cassette	SNI
DS	4890 TwinPeak	3490 cassette	STK
DT	5180	3480 cassette	TANDEM
DU	5190	3480 cassette	TANDEM
DV	RSP 2150 Mountaingate	VHS Kasette	METRUM
DW	OS 25 (HR 650)	CD-ROM	SNI
DW	XM 3501B	CD-ROM	Toshiba
DW	W2001	CD-ROM	SNI
DX	AKEBONO (GY-10D)	DTF-Small	SONY
DX	AKEBONO (GY-10C)	DTF-Large	SONY
DZ	BetaCAM BTS PBC 2800P	BetaCAM	Beta CAM

### 7.2.2 I/O Units

---

- P1: problem box via I/O unit/A
- P2: problem box via I/O unit/B
- P3: problem box via I/O unit/B Mixed-Media
- P4: problem box via I/O unit/B für D2 (7 compartments)
- P5: problem box via I/O unit/C
- P6: problem box via I/O unit/A Mixed Media (7 compartments)
- P6: problem box via I/O unit/E (1 compartment)
- E0: I/O unit/A 120 with 4 handling boxes
- E1: I/O unit/A 240 with 8 handling boxes
- E2: I/O unit/B 60 with 2 handling boxes
- E3: I/O unit/B 120 with 4 handling boxes
- E5: I/O unit/C
- E6: I/O unit/D HICAP (AML/J)
- E5: I/O unit/E with handling box (AML/J)

### 7.2.3 Host Computers

---

- H0: MVS-HACC Host
- H1: VM-HACC Host
- H2: BS 2000 (66 Byte string length)
- H3: BS 2000 (80 Byte string length)
- H4: Tandem Host (66 Byte string length)
- H5: Tandem Host (80 Byte string length)
- H6: HACC/DAS (DAS-Unix and DAS/2 until ver. 1.2mb)
- H7: VolServ, HACC/OS400

### 7.2.4 Storage Units

---

- T0: Quadro tower high
- T1: Quadro tower medium
- T2: Quadro tower small
- T3: Hexa tower high
- T4: Hexa tower medium
- T5: Hexa tower small
- L0: Linear shelf high
- L1: Linear shelf medium
- L2: Linear shelf small

### AML/J Linear Shelves

- L3: Linear shelf on one small drive module
- L4: Linear shelf on two small drive modules
- L5: Linear shelf full height
- L6: Linear shelf one 4 small drive modules
- L7: Linear shelf on 5 small drive modules
- L8: Linear shelf with I/O unit (C or E)
- L9: Linear shelf on three drive modules
- LA: Linear shelf on one big drive module
- LB: Linear shelf on two big drive modules
- LC: Linear shelf on three big drive modules
- LD: Linear shelf beside of I/O unit/E

### 7.2.5 Robots

---

- R0: robot system (AML/2)
- R3: handling unit (AML/E)
- R4: handling unit (AML/J)

### 7.2.6 AMU

---

- A0: AMU without backup AMU
- A1: AMU with backup AMU
- A2: AMU as backup AMU (from release 2.3 not longer in use)

### 7.2.7 Control Units

---

- O0: RHO3, robot control for AML/2 and AML/E
- O1: BDE, control for I/O unit/A
- O2: PMAC, control for AML/J

## 7.3 List of Documents AML/2



### Information

The documents marked with an x are supplied in the file „Documentation for AML/2 components“.

Documents without order number can be ordered by stating the title.

Manual	Language	Order-No.
Operator Guide AML/2	German	B-2.0.A-05D
	English	B-2.0.A-05E
Maintenance Guide AML/2	German	B-2.0.A-06D
	English	B-2.0.A-06E
Manual rho3 Connecting	German	x
	English	x
Manual rho3 Machine Parameters	German	x
	English	x
Manual rho3 PHG Operation	German	x
	English	x
Manual rho3 Description of Extensions	German	x
	English	x
Manual rho3 Signal Description and Error Messages	German	x
	English	x
Manual Drive Amplifiers (MOOG)	German	x
	English	x
Manual Robot SR80-G	German	x
	English	x

## List of Documents AML/2

---

<b>Manual</b>	<b>Language</b>	<b>Order-No.</b>
Manual Vision-System IRIS	German	x
	English	x
Manual Scanner MS-610/615	English	x
Manual Compressor Jun-Air	English	
Documentation IBM PS2	German	
Documentation IBM OS/2	English	
Documentation DCAF	English	

## 7.4 List of Documents AML/E



### Information

The documents marked with an x are supplied in the file „Documentation for AML/E components“.

Documents without order number can be ordered by stating the title.

Manual	Language	Order-No.
Operator Guide AML/E	German	C-2.0.A-05D
	English	C-2.0.A-05E
Maintenance Guide AML/E	German	C-2.0.A-06D
	English	C-2.0.A-06E
Installation Guide AML/E	German	C-2.0.A-03D
	English	C-2.0.A-03E
Manual rho3 Connecting	German	x
	English	x
Manual rho3 Machine Parameters	German	x
	English	x
Manual rho3 PHG Operation	German	x
	English	x
Manual rho3 Description of Extensions	German	x
	English	x
Manual rho3 Signal Description and Error Messages	German	x
	English	x
Manual Drive Amplifier (MOOG)	German	x
	English	x

## List of Documents AML/E

---

<b>Manual</b>	<b>Language</b>	<b>Order-No.</b>
Manual Bosch Handling Unit	German	x
	English	x
Manual Frequency Converter Simovert	German	x
	English	x
Manual Scanner MS-610/615	English	x
Manual Compressor Jun-Air	English	
Documentation IBM PS2	German	
Documentation IBM OS/2	English	
Documentation DCAF	English	

7.4.1 List of Documents AML/J



**Information**

The documents marked with an x are supplied in the file „Documentation for AML/J components“.

Documents without order number can be ordered by stating the title.

Manual	Language	Order-No.
Operator Guide AML/J	German	D-3.0.0-03D
	English	D-3.0.0-03E
Maintenance Guide AML/J	German	D-3.0.0-06D
	English	D-3.0.0-06E
Installation Guide AML/J	German	D-3.0.0-03D
	English	D-3.0.0-03E
Scanner ACCU-Sort Model 20 Operations Manual	English	x
Scanner ACCU-Sort Model 20 Product Programming Manual	English	x
Manual Scanner MS-610/615	English	x
Manual VEXTA CSK Series with TH Gearhead Operating Manual	English	x
Documentation IBM OS/2	English	
Documentation DCAF	English	



## List of Documents AML/E

---

### 7.4.2 List of Documents AMU Software

---

<b>Manual</b>	<b>Language</b>	<b>Order-No.</b>
AMU Installation Guide	German	E-2.2.0-03D
	English	E-2.2.0-03E
AMU Reference Guide	German	E-2.2.0-01D
	English	E-2.2.0-01E

**7.4.3 List of Documents HOST Software**

---

**HACC/MVS**

<b>Manual</b>	<b>Language</b>	<b>Order-No.</b>
General Information Manual	German	H-2.4.0-07D
	English	H-2.4.0-07E
Installation and Customization	German	H-2.4.0-03D
	English	H-2.4.0-03E
System Reference Guide	German	H-2.4.0-01D
	English	H-2.4.0-01E
Operator Guide	German	H-2.4.0-02D
	English	H-2.4.0-02E
Messages and Codes	German	H-2.4.0-08D
	English	H-2.4.0-08E
Operator Quick Reference	German	H-2.4.0-61D
	English	H-2.4.0-61E
ISPF User Guide	German	H-2.4.0-10D
	English	H-2.4.0-10E
Presentation Manual	German	H-2.4.0-04D
	English	H-2.4.0-04E
Release Guide	German	H-2.4.0-11D
	English	H-2.4.0-11E

### HACC/VM

<b>Manual</b>	<b>Language</b>	<b>Order-No.</b>
System Reference Guide	German	HVM-1.3.0-01D
	English	HVM-1.3.0-01E
Installation and Customization	German	HVM-1.3.0-03D
	English	HVM-1.3.0-03E
Operator Guide	German	HVM-1.3.0-02D
	English	HVM-1.3.0-02E

### HACC/OS 400

<b>Manual</b>	<b>Language</b>	<b>Order-No.</b>
Operator Guide	English	G-1.0.A-02E

### HACC/DAS

<b>Manual</b>	<b>Language</b>	<b>Order-No.</b>
Administration Guide	English	F-1.2.0-02E
Interfacing Guide	English	F-2.0.0-14E
Message Manual	English	F-2.0.0-08E
Overview	English	F-1.2.0-15E



## 8 Index

### A

- About ..... 3 -56
- adapter boards ..... 2 -12
- adding a user ..... 4 -33
- ADS
  - Prinziple ..... 2 -8
- Allow selections ..... 3 -17
- AML
  - Management Unit (AMU) ..... 2 -1
  - terms ..... 7 -1
- AML/2
  - trademark ..... 1 -5
- AML/E
  - trademark ..... 1 -5
- AML/J
  - trademark ..... 1 -5
- AMU
  - ARC ..... 2 -16
  - ARCBACK ..... 2 -16
  - ART ..... 2 -16
  - BUD ..... 2 -16
  - communication ..... 2 -2
  - CON ..... 2 -16
  - configuration ..... 3 -86
  - copyright/version ..... 3 -56
  - diskettes ..... 2 -15
  - errors ..... 6 -4
  - hardware ..... 2 -11
  - help ..... 3 -56
  - HOC ..... 2 -16
  - information and errors ..... 6 -34
  - interface ..... 2 -11
  - KRN ..... 2 -16
  - operating console ..... 3 -1
  - RFM ..... 2 -16
  - software ..... 2 -14
  - starting ..... 5 -2
  - tasks ..... 2 -2
  - term ..... 7 -1
  - terminating ..... 5 -3
  - Types ..... 7 -7
- AMU Dynamic ..... 3 -83, 3 -92
- Anschrift ADIC/GRAU Storage Systems  
1 -3
- ARC ..... 2 -16
- ARCBACK ..... 2 -16
- archive
  - AMU command ..... 3 -9
  - catalog (term) ..... 7 -1
  - catalog management ..... 2 -2
  - command in the Service menu 3 -47
  - coordinates (terms) ..... 7 -1
  - term ..... 7 -1
- archive catalog
  - AMU ..... 4 -22
  - backup ..... 4 -22
  - destroyed ..... 4 -22
  - restoring ..... 4 -26
- ART ..... 2 -16
- Attribute ..... 3 -10
- authorized personnel ..... 1 -4
- automatic data swich ..... 3 -93

## Index

---

Automatic Data Switch  
Prinziple ..... 2 -8

## B

---

Backup  
Rho File Manager ..... 4 -12

backup  
archive catalog ..... 4 -22

barcode label (term) ..... 7 -1

Break ..... 3 -45

BUD ..... 2 -16

## C

---

cartridge-No. (term) ..... 7 -3

Clean .... 3 -10, 3 -83, 3 -92, 4 -29

click (term) ..... 7 -1

Close  
all ..... 3 -55  
unit ..... 3 -28

CM/2 ..... 1 -5

Combine Only ..... 3 -13

Combined command ..... 3 -13

command  
selecting ..... 3 -3

command (term) ..... 7 -2

command code ..... 3 -3

Commands menu ..... 3 -20

communication ..... 2 -2

APPC ..... 3 -65

configuration ..... 3 -62

EHLL ..... 3 -69

PMAC ..... 3 -72

RS232 ..... 3 -64

scanner ..... 3 -73

SOTEC Multiport ..... 3 -74

TCP/IP ..... 3 -70

Communications Manager

diskettes ..... 2 -14

component types ..... 7 -4

CON (function) ..... 2 -16

configuration  
communication ..... 3 -62  
of the AML system ..... 3 -57  
procedure ..... 3 -60

configuration (term) ..... 7 -2

connection ..... 3 -58

Continuous send... ..... 3 -45

control units ..... 7 -7

Coordinate ..... 3 -12

Copy ..... 3 -8

copyright ..... 1 -5

C-Owner ..... 3 -10

Crash Count ..... 3 -11

Create Archive ..... 3 -47

Cut ..... 3 -8

## D

---

Database Manager  
diskettes ..... 2 -14

DB 2/2 ..... 1 -5

Delete  
Continuous send... ..... 3 -46  
Rho File Manager ..... 4 -10

delete  
configuration ..... 3 -59

disaster recovery support ..... 4 -37

password ..... 3 -53

starting ..... 3 -54

documentation  
AML/2 ..... 7 -8  
AML/E ..... 7 -10, 7 -12  
AML/J ..... 7 -12  
AMU-Software ..... 7 -13  
HOST-Software ..... 7 -14  
suppliers' ..... 7 -12

drive  
closing ..... 3 -28

## Index

---

emptying ..... 3 -24  
mounting a medium ..... 3 -23  
unloading ..... 3 -29

drives  
configuration ..... 3 -76  
name in hex ..... 3 -58  
types ..... 7 -4

Dynamic ..... 4 -29  
AMU ..... 3 -10  
HACC/MVS ..... 3 -10

## E

---

Edit  
Continuous send ..... 3 -46  
menu ..... 3 -8  
volser ranges ..... 4 -27

Ejected .. 3 -10, 3 -82, 3 -91, 4 -29

Empty ... 3 -10, 3 -82, 3 -91, 4 -29

errors  
application program ..... 6 -22  
barcode ..... 6 -25  
hardware ..... 6 -27  
messages ..... 6 -1  
resolving ..... 6 -1  
rho control ..... 6 -4  
teaching ..... 6 -25

Execute ..... 3 -21

Exit/Save ..... 3 -45

## F

---

failure ..... 3 -1

field  
max. size ..... 3 -2  
symbol ..... 3 -2

File (Trace) ..... 3 -15

File menu ..... 3 -5

Foreign ..... 3 -10, 3 -88, 4 -29

foreign media  
term ..... 7 -2

Format (Trace) ..... 3 -15

## G

---

Get... ..... 3 -36

gripper  
errors ..... 6 -23

## H

---

HACC Dynamic ..... 3 -88

handling box ..... 7 -2

handling unit  
configuration ..... 3 -80  
errors ..... 6 -23  
term ..... 7 -2

hardware  
adapter boards ..... 2 -12

hardware (AMU) ..... 2 -11

hazard alert messages ..... 1 -2

Help menu ..... 3 -56

HOC ..... 2 -16

Homing... ..... 3 -34

host  
computer (term) ..... 7 -2

host computer  
configuration ..... 3 -79  
errors ..... 6 -2

host computers  
types ..... 7 -6

## I

---

I/O unit  
configuration ..... 3 -87  
term ..... 7 -2

## Index

---

I/O-units  
  types ..... 7 -6  
IBM ..... 1 -5  
In Jukebox ..... 3 -10  
in Jukebox ..... 3 -82, 3 -91  
Initial ..... 3 -10  
instruction  
  term ..... 7 -2  
interface ..... 2 -11  
Inventory ..... 3 -26

## J

---

JUSTUTIL.EXE ..... 4 -16

## K

---

Keep ..... 3 -24  
keyboard ..... 3 -1  
KRN ..... 2 -16

## L

---

layout  
  of windows ..... 3 -2  
linear shelf  
  configuration ..... 3 -90  
  term ..... 7 -2  
List ..... 4 -4  
LOG control center ..... 3 -16  
Logical Ranges ..... 3 -88  
Logoff... ..... 3 -44  
Logon... ..... 3 -43  
Look... ..... 3 -37

## M

---

Manual Operation ..... 3 -19  
media

  moving ..... 3 -25  
  term ..... 7 -2  
menu  
  Commands ..... 3 -20  
  Connection (Rho File Manager) 4-4  
  Edit ..... 3 -8  
  File (AMU) ..... 3 -5  
  File (Rho File Manager) ..... 4 -3  
  Help ..... 3 -56  
  Options ..... 3 -18  
  overview ..... 3 -4  
  Service ..... 3 -43  
  View ..... 3 -9  
  Window ..... 3 -55  
menu bar ..... 3 -2  
messages  
  rho control ..... 6 -4  
Mount ..... 3 -23  
Mounted . 3 -10, 3 -82, 3 -91, 4 -29  
mounting media ..... 3 -23  
mouse ..... 3 -1  
Move ..... 3 -25  
MTCG Dialog ..... 3 -41  
multi-tasking ..... 2 -15

## O

---

Occupied ..... 3 -10, 3 -82, 3 -91  
online help ..... 3 -2  
operating console  
  starting ..... 5 -2  
  terminating ..... 5 -3  
operating panel ..... 7 -2  
operator  
  term ..... 7 -2  
Operator Guide ..... 1 -4  
Options menu ..... 3 -18  
OS/2 ..... 1 -5



## Index

---

- diskettes ..... 2 -14
- ### P
- 
- Partner ..... 4 -4
  - Paste ..... 3 -8
  - Print ..... 3 -5
  - Problem ..... 3 -10, 3 -88, 4 -29
  - problem box
    - configuration ..... 3 -85
    - term ..... 7 -3
  - product observation ..... 1 -6
  - Purge... ..... 3 -33
  - Put... ..... 3 -35
- ### Q
- 
- Quadro tower
    - term ..... 7 -3
- ### R
- 
- Receive from Rho ..... 4 -8
  - Rename ..... 4 -11
  - Reset ..... 3 -21
  - Restore ..... 3 -48, 4 -14
  - Reverse Side Mounted 3 -10, 3 -82, 3 -91
  - RFM ..... 2 -16
  - robot
    - configuration ..... 3 -80
  - robots
    - types ..... 7 -7
- ### S
- 
- Save
    - to list ..... 3 -46
    - to list (before) ..... 3 -46
  - save
    - configuration ..... 3 -59
  - scanner ..... 3 -96
  - scratch media ..... 7 -3
  - selecting a command ..... 3 -3
  - Send one ..... 3 -45
  - Send to Rho ..... 4 -5
  - Service menu ..... 3 -43
  - shutdown
    - AML system ..... 5 -3
    - AMU computer ..... 5 -3
  - Shutdown ABBA ..... 3 -6, 3 -7
  - Simulation only ..... 3 -18
  - software
    - AMU ..... 2 -15
    - Communications Manager .. 2 -14
    - Database Manager ..... 2 -14
    - OS/2 ..... 2 -14
  - software (AMU) ..... 2 -14
  - software tools
    - JUSTUTIL.EXE ..... 4 -16
  - Start (LOG Control Center) .... 3 -16
  - Start Cnt ..... 3 -45
  - starting
    - CON and KRN ..... 5 -2
  - starting the Rho File Manager .... 4 -2
  - Status ..... 3 -21, 3 -31
  - Stop
    - Alerter ..... 3 -47
    - Cnt ..... 3 -45
  - Storage ..... 3 -83, 3 -92, 4 -29
  - storage tower
    - configuration ..... 3 -81
    - errors ..... 6 -28
  - storage units ..... 7 -6
  - String
    - Command ..... 3 -21
    - conventions ..... 3 -22
  - Switch Combine Only ..... 3 -13

## Index

---

switching off  
    with Shutdown ABBA .. 3 -6, 3 -7

symbols  
    formats ..... 1 -1  
    hazard alert messages ..... 1 -2  
    information ..... 1 -1

system media  
    term ..... 7 -3

system menu field ..... 3 -2

system shutdown OS/2 ..... 5 -4

## T

---

teach label  
    term ..... 7 -3

Teach single command ..... 3 -39

teachen  
    term ..... 7 -3

teaching  
    all components ..... 3 -41  
    errors ..... 6 -25  
    single component ..... 3 -39

Temp  
    Away ..... 3 -10  
    Here ..... 3 -10

terminating  
    CON and KRN ..... 5 -3

terms ..... 7 -1

title bar ..... 3 -2

trace  
    command ..... 3 -14  
    levels ..... 3 -97

Turn... ..... 3 -38

turning unit ..... 7 -3

type  
    of compartment ..... 3 -10

## U

---

Undefined ..... 3 -10

Unload Unit ..... 3 -29

Unselect all (LOG Control Center) 3 -16

Update  
    Coordinate ..... 3 -12  
    Devices ..... 3 -47

Use Count ..... 3 -10

used terms ..... 7 -1

## V

---

View  
    Coordinate ..... 3 -12  
    menu ..... 3 -9  
    Volser ..... 3 -11

View Log ..... 3 -17

ViewLog ..... 3 -17

Volser  
    term ..... 7 -3

Volser ranges ..... 3 -82

VSN (term) ..... 7 -3

## W

---

window  
    altering size ..... 3 -3  
    closing ..... 3 -3  
    corner ..... 3 -2  
    frame ..... 3 -2  
    moving ..... 3 -3

Window menu ..... 3 -55

windows  
    layout ..... 3 -2